



Cennik 2023

DYKA
Nature's Network

kwiecień 2023



1.	Rury kanalizacji zewnętrznej z PVC-U.	4	
2.	Kształtki kanalizacji zewnętrznej z PVC-U.	6	
3.	Rury i kształtki kanalizacji zewnętrznej z PP SOLYDO SN10	9	<i>NOWOŚĆ</i>
4.	Kinety, rury wznoszące, teleskopy.	10	
5.	Żeliwo drogowe	13	
6.	Studnie ø600 AXEDO	14	
7.	Kanalizacja zewnętrzna z PP (korugowana)	16	
8.	System kanalizacji wewnętrznej niskosumowej DYKA PRO	18	
9.	Kanalizacja wewnętrzna z PP (biała).	21	
10.	Rury ciśnieniowe z PE.	22	
11.	Studzienki wodomierzowe	22	
12.	Taśma lokalizacyjna	23	
13.	Rura gazowa.	24	
14.	Złączki elektrooporowe do rur PE100.	24	
15.	Złączki skręcane do rur PE.	26	
16.	Rury i kształtki wodociągowe z PVC-U (bez uszczelek)	29	
17.	Armatura wodociągowa.	30	
18.	System drenarski	34	
19.	Chemia budowlana.	34	
20.	Skrzynki, tunele i zbiorniki na wodę	35	<i>NOWOŚĆ</i>
21.	Rury do nawadniania	35	
22.	System studzienny	36	<i>NOWOŚĆ</i>
23.	System klejony PVC.	37	
24.	Odwodnienia liniowe.	40	
25.	Grawitacyjne systemy odwodnienia dachów	41	
26.	Podciśnieniowe systemy odwodnienia dachów płaskich - VACURAIN . . .	42	

Rury kanalizacji zewnętrznej z PVC-U ze ścianką z rdzeniem spienionym ULTRA-3

Rura kanalizacyjna kielichowa PVC-U spieniona, SN2, Szereg: SDR 51, Typ: lekki ITB-KOT-2017/0210 wydanie 2



Nr art.	DN/OD [mm]	Grubość ścianki [mm]	L [m]	Ilość w opakowaniu	Cena netto [zł/szt.]	Cena netto [zł/mb]
4110010-4	160	3,2	0,5	4	31,66	63,32
4110020-4	160	3,2	1,0	28	48,17	48,17
4110030-4	160	3,2	2,0	28	83,22	41,61
4110040-4	160	3,2	3,0	28	119,19	39,73
4110050-4	160	3,2	4,0	28	164,72	41,18
4110060-4	160	3,2	6,0	28	234,07	39,01
4110080-4	200	3,9	1,0	20	80,42	80,42
4110090-4	200	3,9	2,0	20	139,29	69,64
4110100-4	200	3,9	3,0	20	201,05	67,02
4110110-4	200	3,9	4,0	20	265,66	66,41
4110120-4	200	3,9	6,0	20	380,55	63,43
4110176-4	250	4,9	3,0	16	339,10	113,03
4110180-4	250	4,9	6,0	19	640,60	106,77
4110210-4	315	6,2	3,0	9	457,01	152,34
4110240-4	315	6,2	6,0	9	863,26	143,88

Rury kanalizacji zewnętrznej z PVC-U ze ścianką z rdzeniem spienionym ULTRA-3; PN-EN 13476-2+A1:2020-12

Rura kanalizacyjna kielichowa PVC-U spieniona, SN8, Szereg: SDR 34, Typ: ciężki



Nr art.	DN/OD [mm]	Grubość ścianki [mm]	L [m]	Ilość w opakowaniu	Cena netto [zł/szt.]	Cena netto [zł/mb]
4130010-4	110	3,2	0,5	10	24,15	48,30
4130020-4	110	3,2	1,0	60	34,74	34,74
4130030-4	110	3,2	2,0	60	61,06	30,53
4130040-4	110	3,2	3,0	60	88,37	29,46
4130060-4	110	3,2	6,0	60	170,64	28,44
4130070-4	160	4,7	0,5	4	41,52	83,04
4130080-4	160	4,7	1,0	28	70,36	70,36
4130090-4	160	4,7	2,0	28	127,81	63,90
4130100-4	160	4,7	3,0	28	182,38	60,79
4130120-4	160	4,7	6,0	28	357,58	59,60
4130140-4	200	5,9	1,0	20	112,02	112,02
4130150-4	200	5,9	2,0	20	188,12	94,06
4130160-4	200	5,9	3,0	20	272,85	90,95
4130180-4	200	5,9	6,0	20	532,77	88,80
4130190-4	250	7,3	2,0	16	337,47	168,74
4130200-4	250	7,3	3,0	16	458,11	152,70
4130220-4	250	7,3	6,0	16	887,48	147,91
4130240-4	315	9,2	3,0	9	725,20	241,73
4130260-4	315	9,2	6,0	9	1 391,54	231,92
4130280-4	400	11,7	3,0	3	1 171,82	390,61
4130300-4	400	11,7	6,0	3	2 280,45	380,07

Rury kanalizacji zewnętrznej z PVC-U ze ścianką z rdzeniem spienionym ULTRA-3; PN-EN 13476-2+A1:2020-12

Rura kanalizacyjna kielichowa PVC-U spieniona, SN4, Szereg: SDR41, Typ: średni



Nr art.	DN/OD [mm]	Grubość ścianki [mm]	L [m]	Ilość w opakowaniu	Cena netto [zł/szt.]	Cena netto [zł/mb]
4120003-4	110	3,2	0,5	10	22,51	45,02
4120004-4	110	3,2	1,0	60	32,83	32,83
4120005-4	110	3,2	2,0	60	57,30	28,65
4120006-4	110	3,2	3,0	60	81,86	27,29
4120007-4	110	3,2	4,0	60	112,02	28,00
4120008-4	110	3,2	5,0	60	143,60	28,72
4120009-4	110	3,2	6,0	60	162,27	27,05
4120250-4	125	3,2	0,5	7	24,41	48,82
4120261-4	125	3,2	1,0	40	40,20	40,20
4120271-4	125	3,2	2,0	40	70,36	35,18
4120281-4	125	3,2	3,0	40	100,51	33,50
4120301-4	125	3,2	5,0	40	165,15	33,03
4120010-4	160	4,0	0,5	28	35,44	70,88
4120020-4	160	4,0	1,0	28	56,73	56,73
4120030-4	160	4,0	2,0	28	103,40	51,70
4120040-4	160	4,0	3,0	28	152,22	50,74
4120050-4	160	4,0	4,0	28	200,89	50,22
4120051-4	160	4,0	5,0	28	274,28	54,86
4120060-4	160	4,0	6,0	28	292,94	48,82
4120080-4	200	4,9	1,0	20	93,33	93,33
4120090-4	200	4,9	2,0	20	156,53	78,27
4120100-4	200	4,9	3,0	20	226,90	75,63
4120111-4	200	4,9	5,0	20	387,73	77,55
4120120-4	200	4,9	6,0	20	449,48	74,91
4120129-4	250	6,2	1,0	16	165,15	165,15
4120130-4	250	6,2	2,0	16	274,28	137,14
4120140-4	250	6,2	3,0	16	390,61	130,20
4120151-4	250	6,2	5,0	16	667,76	133,55
4120160-4	250	6,2	6,0	16	749,61	124,94
4120169-4	315	7,7	1,0	9	267,10	267,10
4120170-4	315	7,7	2,0	9	458,09	229,05
4120180-4	315	7,7	3,0	9	639,03	213,01
4120191-4	315	7,7	5,0	9	1 055,49	211,10
4120200-4	315	7,7	6,0	9	1 206,28	201,05
4120209-4	400	9,8	1,0	3	449,48	449,48
4120210-4	400	9,8	2,0	3	753,93	376,96
4120220-4	400	9,8	3,0	3	1 012,42	337,47
4120231-4	400	9,8	5,0	3	1 701,71	340,34
4120240-4	400	9,8	6,0	3	1 938,66	323,11

Rury kanalizacji zewnętrznej z PVC-U ze ścianką litą;
PN-EN 1401-1:2019-07

Rura kanalizacyjna kielichowa PVC-U lita, SN4, Szereg: SDR 41, Typ: średni							
Nr art.	DN/OD [mm]	Grubość ścianki [mm]	L [m]	Ilość w opakowaniu	Cena netto [zł/szt.]	Cena netto [zł/mb]	
4120021-4	160	4,0	1,0	28	79,57	79,57	
4120031-4	160	4,0	2,0	28	133,54	66,77	
4120041-4	160	4,0	3,0	28	187,49	62,50	
4120061-4	160	4,0	6,0	28	369,59	61,60	

Rury kanalizacji zewnętrznej z PVC-U ze ścianką litą;
PN-EN 1401-1:2019-07

Rura kanalizacyjna kielichowa PVC-U lita, SN8, Szereg: SDR 34, Typ: ciężki							
Nr art.	DN/OD [mm]	Grubość ścianki [mm]	L [m]	Ilość w opakowaniu	Cena netto [zł/szt.]	Cena netto [zł/mb]	
4130012-4	110	3,2	0,5	10	27,57	55,14	
4130022-4	110	3,2	1,0	60	45,31	45,31	
4130032-4	110	3,2	2,0	60	81,64	40,82	
4130042-4	110	3,2	3,0	60	115,01	38,34	
4130062-4	110	3,2	6,0	60	224,16	37,36	
4130072-4	160	4,7	0,5	4	54,36	108,72	
4130082-4	160	4,7	1,0	28	92,29	92,29	
4130091-4	160	4,7	2,0	28	168,96	84,48	
4130102-4	160	4,7	3,0	28	222,21	74,07	
4130122-4	160	4,7	6,0	28	441,59	73,60	
4130142-4	200	5,9	1,0	20	149,08	149,08	
4130151-4	200	5,9	2,0	20	254,16	127,08	
4130162-4	200	5,9	3,0	20	348,08	116,03	
4130182-4	200	5,9	6,0	20	681,54	113,59	
4130191-4	250	7,3	1,0	16	262,45	262,45	
4130192-4	250	7,3	2,0	16	414,60	207,30	
4130202-4	250	7,3	3,0	16	580,74	193,58	
4130222-4	250	7,3	6,0	16	1 120,30	186,72	
4130231-4	315	9,2	1,0	9	425,97	425,97	
4130232-4	315	9,2	2,0	9	685,80	342,90	
4130242-4	315	9,2	3,0	9	891,69	297,23	
4130262-4	315	9,2	6,0	9	1 716,66	286,11	
4130272-4	400	11,7	2,0	3	1 162,89	581,44	
4130282-4	400	11,7	3,0	3	1 455,40	485,13	
4130302-4	400	11,7	6,0	3	2 827,00	471,17	

Rury kanalizacji zewnętrznej z PVC-U ze ścianką litą,
PN-EN 1401-1:2019-07

Rura kanalizacyjna kielichowa z wydłużonym kielichem PVC-U lita, SN8, Szereg: SDR 34, Typ: ciężki							
Nr art.	DN/OD [mm]	Grubość ścianki [mm]	L [m]	Ilość w opakowaniu	Cena netto [zł/szt.]	Cena netto [zł/mb]	
4130085-4	160 *	4,7	1,0	28	102,23	102,23	
4130095-4	160 *	4,7	2,0	28	188,84	94,42	
4130103-4	160 *	4,7	3,0	28	244,22	81,41	
4130123-4	160 *	4,7	6,0	28	468,57	78,09	
4130163-4	200 *	5,9	3,0	20	386,21	128,74	
4130183-4	200 *	5,9	6,0	20	741,18	123,53	
4130203-4	250 *	7,3	3,0	16	596,35	198,78	
4130223-4	250 *	7,3	6,0	16	1 134,49	189,08	
4130243-4	315 *	9,2	3,0	9	962,68	320,89	
4130263-4	315 *	9,2	6,0	9	1 801,84	300,31	

Środek poślizgowy do rur kanalizacyjnych (DYKA Vaseline)

Nr art.	Waga	Cena netto [zł/szt.]
4630001	1000 g	99,21



Kolano 15°



Nr art.	DN [mm]	Ilość w opakowaniu	Cena netto [zł/szt.]
4603010	110	40	11,25
4603011	125	40	24,24
4603020	160	15	24,50
4603030	200	10	53,98
4603040	250	1	131,82
4603050	315	1	209,65
4603060	400	1	514,71

Kolano 30°



Nr art.	DN [mm]	Ilość w opakowaniu	Cena netto [zł/szt.]
4604010	110	40	11,64
4604011	125	40	28,86
4604020	160	15	26,24
4604030	200	10	59,38
4604040	250	1	158,81
4604050	315	1	237,52
4604060	400	1	597,95

Kolano 45°



Nr art.	DN [mm]	Ilość w opakowaniu	Cena netto [zł/szt.]
4605010	110	30	11,93
16005011	125	40	25,07
4605020	160	15	26,30
4605030	200	6	47,71
4605040	250	4	150,65
4605050	315	1	233,50
4605060	400	1	839,86

Kolano 67°



Nr art.	DN [mm]	Ilość w opakowaniu	Cena netto [zł/szt.]
4606010	110	30	13,45
4606011	125	40	28,52
4606020	160	10	36,60
4606030	200	1	64,03

Kolano 87°



Nr art.	DN [mm]	Ilość w opakowaniu	Cena netto [zł/szt.]
4607010	110	25	14,15
4607011	125	40	31,62
4607020	160	8	34,56
4607030	200	4	62,76
4607040	250	3	163,20
4607050	315	1	288,74
4607060	400	1	814,76

Trójnik 45°



Nr art.	DN [mm]	Ilość w opakowaniu	Cena netto [zł/szt.]
4601010	110 x 110	15	23,85
4601011	125 x 110	15	51,09
4601015	125 x 125	15	58,97
4601020	160 x 110	8	41,55
4601030	160 x 160	5	61,51
4601040	200 x 110	1	96,67
4601050	200 x 160	1	99,18
4601060	200 x 200	1	116,12
4601070	250 x 110	1	202,75
4601080	250 x 160	1	213,42
4601090	250 x 200	1	238,53
4601100	250 x 250	1	327,66
4601110	315 x 110	1	338,96
4601120	315 x 160	1	316,36
4601130	315 x 200	1	504,67
4601140	315 x 250	1	520,99
4601150	315 x 315	1	872,50
4601170	400 x 160	1	778,35
4601180	400 x 200	1	864,97
4601190	400 x 250	1	1254,15
4601200	400 x 315	1	2132,93
4601210	400 x 400	1	2635,09

Trójnik 67°



Nr art.	DN [mm]	Ilość w opakowaniu	Cena netto [zł/szt.]
4601510	160 x 110	5	54,45
4601520	160 x 160	5	70,95

Trójnik 87° SWEPT



Nr art.	DN [mm]	Ilość w opakowaniu	Cena netto [zł/szt.]
4602012	110 x 110	1	35,19
4602020S	160 x 110	1	51,48
4602030S	160 x 160	1	62,77

Trójnik 87°



Nr art.	DN [mm]	Ilość w opakowaniu	Cena netto [zł/szt.]
4602010	110 x 110	15	24,89
4602011	125 x 110	15	43,16
4602015	125 x 125	15	48,13
4602020	160 x 110	8	41,43
4602030	160 x 160	6	60,26
4602040	200 x 110	1	94,16
4602050	200 x 160	1	99,18
4602060	200 x 200	1	114,24
4602070	250 x 110	1	207,14
4602080	250 x 160	1	214,67
4602090	250 x 200	1	238,53
4602100	250 x 250	1	271,17
4602110	315 x 110	1	338,96
4602120	315 x 160	1	279,95
4602130	315 x 200	1	633,98
4602140	315 x 250	1	621,42
4602150	315 x 315	1	719,35
4602170	400 x 160	1	1148,69
4602180	400 x 200	1	1580,55
4602190	400 x 250	1	1706,09
4602200	400 x 315	1	2032,50
4602210	400 x 400	1	2459,33

Nasuwka



Nr art.	DN [mm]	Ilość w opakowaniu	Cena netto [zł/szt.]
4608010	110	50	11,38
4608011	125	50	24,93
4608020	160	20	22,60
4608030	200	10	42,68
4608040	250	5	138,09
4608050	315	3	210,91
4608060	400	1	489,61

Złączka dwukielichowa



Nr art.	DN [mm]	Ilość w opakowaniu	Cena netto [zł/szt.]
4609010	110	50	11,24
4609011	125	50	24,93
4609020	160	20	25,10
4609030	200	10	53,98
4609040	250	1	163,20
4609050	315	1	267,40
4609060	400	1	877,53

Czyszczyzak



Nr art.	DN [mm]	Ilość w opakowaniu	Cena netto [zł/szt.]
4610010	110	20	47,71
4610020	160	8	133,68
4610030	200	8	232,25

Redukcja



Nr art.	DN [mm]	Ilość w opakowaniu	Cena netto [zł/szt.]
4611010	160/110	20	17,45
4611011	160/125	1	27,97
4611020	200/160	10	32,64
4611030	250/200	1	153,16
4611042	315/160	1	345,24
4611039	315/200	1	343,98
4611040	315/250	1	282,47
4611050	400/315	1	488,35

Redukcja krótka



Nr art.	DN [mm]	Ilość w opakowaniu	Cena netto [zł/szt.]
4611010K	160/110	1	19,60

Korek



Nr art.	DN [mm]	Ilość w opakowaniu	Cena netto [zł/szt.]
4612010	110	100	5,90
4612011	125	100	11,30
4612020	160	25	9,92
4612030	200	15	21,88
4612040	250	1	76,58
4612050	315	1	124,28
4612060	400	1	269,91

Zaślepka



Nr art.	DN [mm]	Ilość w opakowaniu	Cena netto [zł/szt.]
4613010	110	125	7,66
4613011	125	1	18,86
4613020	160	40	17,45
4613030	200	40	33,27
4613040	250	1	74,70
4613050	315	1	131,82
4613060	400	1	212,16

Odgańlenie nasadowe

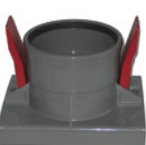

Nr art.	DN [mm]	Ilość w opakowaniu	Cena netto [zł/szt.]
4614010	250 x 160	1	602,59
4614020	315 x 160	1	477,05

Piła wyrzynarka



Nr art.	DN [mm]	Ilość w opakowaniu	Cena netto [zł/szt.]
68209	159	1	1 212,72

Złączka PVC/żeliwo KGUG



Nr art.	DN [mm]	Ilość w opakowaniu	Cena netto [zł/szt.]
4615010	110	1	23,85
4615020	160	1	62,77
4615030	200	1	138,09

Uszczelka do KGUG

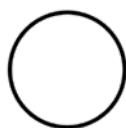

Nr art.	DN [mm]	Ilość w opakowaniu	Cena netto [zł/szt.]
4620010	110		14,19
4620020	160		29,00
4620030	200		47,71

Złączka PVC (Bosy Koniec)/kamionka (Kielich)



Nr art.	DN [mm]	Ilość w opakowaniu	Cena netto [zł/szt.]
4616010	110 x 136		62,77
4616020	160 x 190		99,18
4616030	200 x 242		175,76

Złączka kamionka (Bosy Koniec)/PVC (Kielich)



Nr art.	DN [mm]	Ilość w opakowaniu	Cena netto [zł/szt.]
4617010	136 x 110		51,47
4617020	190 x 160		120,52
4617030	242 x 200		301,30

Tuleja ochronna krótka



Nr art.	DN [mm]	Ilość w opakowaniu	Cena netto [zł/szt.]
4618010	110	1	32,64
4618070	125	16	150,65
4618020	160	14	41,43
4618030	200	1	61,51
4618040	250	1	115,50
4618050	315	1	151,90
4618060	400	1	217,18

Tuleja ochronna długa



Nr art.	DN [mm]	Ilość w opakowaniu	Cena netto [zł/szt.]
4622010	110	1	61,51
4622020	160	8	71,56
4622030	200	6	80,97
4622040	250	1	189,57
4622050	315	1	249,82
4622060	400	1	500,91

Uszczelki do kielichów PVC

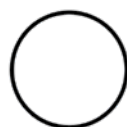

Nr art.	DN [mm]	Ilość w opakowaniu	Cena netto [zł/szt.]
0110005	110		0,81
0110006	160		1,92
0110007	200		2,98
0110008	250		6,53
0110009	315		11,30
0110010	400		23,60

Zasuwa burzowa końcowa drenarska uniwersalna



Nr art.	Średnica DN [mm]	Cena netto [zł/szt.]
4619050	80/100	164,13

Zasuwa burzowa



Nr art.	Średnica DN [mm]	Cena netto [zł/szt.]
4619010	110	235,37
4619020	160	305,35

Zasuwa burzowa 50 szara TYP A



Nr art.	Średnica DN [mm]	Cena netto [zł/szt.]
4619000	50	87,79

Zasuwa burzowa 50 biała z kolaniem montażowym TYP C



Nr art.	Średnica DN [mm]	Cena netto [zł/szt.]
4619003	50	87,79

Zasuwa burzowa końcowa



Nr art.	Średnica DN [mm]	Cena netto [zł/szt.]
4619060	110	164,13
4619070	160	203,57

Rury kanalizacji zewnętrznej PP SN10 SOLYDO



Nr art.	DN/OD [mm]	Grubość ścianki [mm]	L [m]	Ilość w opakowaniu	Cena netto [zł/szt.]	Cena netto [zł/mb]
20031505	160	6,2	3,0	24	203,06	67,69
20031510	200	7,7	3,0	20	308,75	102,92
20031512	250	9,6	3,0	12	491,63	163,88
20031514	315	12,1	3,0	6	739,22	246,41
20031597	400	15,3	3,0	4	1200,56	400,19

KSZTAŁTKI KANALIZACJI ZEWNĘTRZNEJ PP SOLYDO RAL8023



Kolano

Nr art.	DN [mm]	Ilość w opakowaniu	Cena netto [zł/szt.]
20027347	160/15	144	22,23
20027351	160/30	112	23,37
20027355	160/45	96	27,65
20027359	160/90	88	32,63
20027369	200/15	48	50,73
20027373	200/30	56	53,87
20038954	200/45	32	46,83
20038956	200/90	32	64,98

Nasuwka

Nr art.	DN [mm]	Ilość w opakowaniu	Cena netto [zł/szt.]
20050548	160	192	26,51
20045677	200	64	49,42
20044760	250	32	171,33
20045678	315	18	274,25

Trójnik

Nr art.	DN [mm]	Ilość w opakowaniu	Cena netto [zł/szt.]
20027363	160/160/45	48	61,51
20031520	160/160/90	28	56,29
20038957	200/200/45	15	136,23
20027398	200/200/90	17	129,61
20027386	200/160/45	21	123,83
20027399	200/160/90	1	105,74

Redukcja

Nr art.	DN [mm]	Ilość w opakowaniu	Cena netto [zł/szt.]
20027411	200/160	80	56,00
20027412	250/200	24	227,00
20027413	315/250	21	371,07

DYKA SOLYDO PP - System odpływowy z polipropylenu, produkowany jest zgodnie z normą PN-EN 1852-1_2018-02.

W przeprowadzonych testach w akredytowanych laboratoriach KIWA oraz BECETEL rury SOLYDO uzyskały wytrzymałość obwodową przekraczającą 14kN/m².

Charakterystyka systemu:

- Rury wytwarzane ze 100% polipropylenu high modulus (PP-HM)
- System uszczelkowy z prostymi połączeniami kielichowymi
- Wysoka odporność na pęknięcia, zgniecenia, złamania
- Wysoka odporność na wysokie temperatury i działanie roztworów chemicznych
- Możliwość stosowania w obszarze ruchu transportu ciężarowego
- Kompatybilność średnic ze standardowym systemem gładkiej kanalizacji PVC
- Lekki materiał ograniczający użycie ciężkiego sprzętu budowlanego przy montażu
- Kielichy rur z olejoodporną uszczelką z pierścieniem wzmacniającym

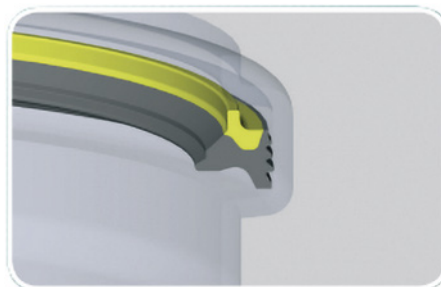

Kinety studni rewizyjnej dla rury wznoszącej \varnothing 315 mm gładkiej Kineta przelotowa z PP, TYP I

	Nr art.	DN [mm]	Opis	szt.	Cena netto [zł/szt.]
	4701030U	315 / 160	przelotowa	1	132,00

Rury wznoszące \varnothing 315 mm (gładkie, bez kielicha)

	Nr art.	DN [mm]	Klasa	Długość [mm]	Ilość w opakowaniu	Cena netto [zł/szt.]
	4705010-4	315	SN2	1,0	9	104,89
4705020-4	315	SN2	2,0	9	179,35	
4705030-4	315	SN2	3,0	9	257,45	
4705060-4	315	SN2	6,0	9	498,48	

Pokrywa PP 315 A15 do rury gładkiej

	Nr art.	DN [mm]	Klasa	Opis	Ilość w opakowaniu	Cena netto [zł/szt.]
	4702032	315	A -1,5 T	pokrywa czarna	1	58,03

Pokrywy teleskopowe – patrz strona 13

Kinety studni rewizyjnej dla rury wznoszącej \varnothing 400 mm gładkiej Kineta przelotowa z PP, TYP I

	Nr art.	DN [mm]	Opis	szt.	Cena netto [zł/szt.]
	4701020	400 / 160	przelotowa	1	207,24
4701050	400 / 200	przelotowa	1	225,20	
4701060	400 / 250	przelotowa	1	697,70	
4701061	400 / 315	przelotowa	1	822,04	

Kinety studni rewizyjnej dla rury wznoszącej \varnothing 400 mm gładkiej Kineta zbiorcza z PP, TYP II

	Nr art.	DN [mm]	Opis	szt.	Cena netto [zł/szt.]
	4701010	400 / 160	3 dopływy	1	241,78
4701011	400 / 200	3 dopływy	1	266,64	
4701012	400 / 250	3 dopływy	1	902,17	
4701018	400 / 315	3 dopływy	1	1 450,66	

Rury wznoszące \varnothing 400 mm (gładkie, bez kielicha)

	Nr art.	DN [mm]	Klasa	Długość [mm]	Ilość w opakowaniu	Cena netto [zł/szt.]
	4705070-4	400	SN2	1,0	3	154,16
4705075-4	400	SN2	1,5	3	224,51	
4705080-4	400	SN2	2,0	3	296,35	
4705090-4	400	SN2	3,0	3	435,54	
4705120-4	400	SN2	6,0	3	868,09	

Pokrywa PP 400 A15 do rury gładkiej

	Nr art.	DN [mm]	Klasa	Opis	Ilość w opakowaniu	Cena netto [zł/szt.]
	4702030	400	A -1,5 T	pokrywa czarna	1	95,33

Manszety

	Nr art.	Nazwa produktu	Cena netto [zł/szt.]
	4704020	Manszeta 315/250	34,54
4704010	Manszeta 400/315	42,83	

Pokrywy teleskopowe – patrz strona 13

Kinety studni rewizyjnej z uszczelką dla rury wznoszącej
Ø 315 mm korugowanej

	Nr art.	DN [mm]	Opis	szt.	Cena netto [zł/szt.]
	IN8531160	315/160RG	przelotowa	1	121,58
	IN8531200	315/200RG	przelotowa	1	138,16
	IN8532160	315/160RG	zbiorcza	1	169,93
	IN8532200	315/200RG	zbiorcza	1	201,71

Rury wznoszące Ø 315 mm (korugowane, bez kielicha)

	Nr art.	Średnica [mm]	Długość [mm]	m	Cena netto [zł/mb]
	IN8533600	ø 315	6000	1	67,70

Pokrywa PP 315 A15 do rury korugowanej

	Nr art.	Średnica [mm]	Opis	szt.	Cena netto [zł/szt.]
	4702031	ø 315	pokrywa czarna	1	50,77

Dno PP 315 A15 do rury korugowanej

	Nr art.	Średnica [mm]	Opis	szt.	Cena netto [zł/szt.]
	4702000	ø 315	dno czarne	1	39,90

Uszczelka do rury korugowanej 315

	Nr art.	Średnica [mm]	szt.	Cena netto [zł/mt.]
	IN8700012	ø 315	1	27,64

Stożek betonowy z pokrywą 315

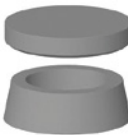
	Nr art.	Opis	Średnica [mm]	szt.	Cena netto [zł/szt.]
	IN8700030	Stożek	ø 315	1	63,94
	IN8700040	Pokrywa	ø 315	1	47,27

Pokrywy teleskopowe – patrz strona 13

Kinety studni rewizyjnej z uszczelką dla rury wznoszącej
Ø 400K korugowanej

	Nr art.	DN [mm]	Opis	szt.	Cena netto [zł/szt.]
	IN8401160	400K RK/160 RG	przelotowa	1	182,37
	IN8401200	400K RK/200 RG	przelotowa	1	211,38
	IN8401250	400K RK/250 RG	przelotowa	1	707,89
	IN8401315	400K RK/315 RG	przelotowa	1	649,34
	IN8401400	400K RK/400 RG	przelotowa	1	522,24
	IN8402160	400K RK/160 RG	zbiorcza	1	275,50
	IN8402200	400K RK/200 RG	zbiorcza	1	255,59
	IN8402250	400K RK/250 RG	zbiorcza	1	1 063,82
	IN8402315	400K RK/315 RG	zbiorcza	1	1 284,87

Rury wznoszące Ø 400K mm (korugowane, bez kielicha)

	Nr art.	Średnica [mm]	Długość [mm]	m	Cena netto [zł/mb]
	IN8403600	ø 400	6000	1	246,45

Pokrywa PP 400 A15 do rury korugowanej

	Nr art.	Średnica [mm]	Opis	szt.	Cena netto [zł/szt.]
	4702035	ø 400	pokrywa czarna	1	95,33

Manszeta gumowa 400/315

	Nr art.	Średnica [mm]	szt.	Cena netto [zł/szt.]
	AR892427	400/315	1	80,13

Uszczelka do rury korugowanej 400

	Nr art.	Średnica [mm]	szt.	Cena netto [zł/szt.]
	IN8700015	400	1	61,54

Stożek betonowy z pokrywą 400

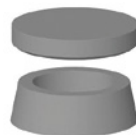
	Nr art.	Opis	Średnica [mm]	szt.	Cena netto [zł/szt.]
	IN8700032	Stożek	ø 400	1	91,06
	IN8700042	Pokrywa	ø 400	1	53,98

Kinety studni rewizyjnej z uszczelką dla rury wznoszącej Ø 425 NW korugowanej



Nr art.	DN [mm]	Opis	szt.	Cena netto [zł/szt.]
IN8500025	424 RK/160 RG	przelotowa	1	248,68
IN8500026	425 RK/200 RG	przelotowa	1	273,55
IN8500027	425 RK/250 RG	przelotowa	1	656,25
IN8500028	425 RK/300 RG	przelotowa	1	663,16
IN8500029	425 RK/400 RG	przelotowa	1	794,08
IN8500018	425 RK/160 RG	zbiorcza	1	284,61
IN8500019	425 RK/200 RG	zbiorcza	1	313,62
IN8500020	425 RK/250 RG	zbiorcza	1	1 155,00
IN8500022	425 RK/315 RG	zbiorcza	1	1 322,17

Uszczelki IN-SITU do rury korugowanej 400



Nr art.	Średnica [mm]	szt.	Cena netto [zł/szt.]
4704030	110/138	1	17,07
4704040	160/177	1	26,26
4704050	200/226	1	43,32

Rury wznoszące Ø 425NW (korugowane, bez kielicha)



Nr art.	Średnica [mm]	Długość [mm]	m	Cena netto [zł/mb]
IN8500120	Ø 425	6000	1	245,07

Pokrywa PP 425 A15 do rury korugowanej



Nr art.	DN [mm]	Klasa	Opis	Ilość w opakowaniu	Cena netto [zł/szt.]
4702029	425	A -1,5 T	pokrywa czarna	1	83,38

Manszeta



Nr art.	Nazwa produktu	Cena netto [zł/szt.]
4704017	Manszeta 475/315	82,85

Uszczelka do rury korugowanej 425/400



Nr art.	Średnica [mm]	szt.	Cena netto [zł/szt.]
4704005	425	1	61,54

Dno PP 425 do rury korugowanej



Nr art.	Średnica [mm]	Opis	szt.	Cena netto [zł/szt.]
KA8800011	Ø 425	dno czarne	1	68,46

Włazy polimerowe



Nr art.	Opis	szt.	Cena netto [zł/szt.]
WŁ0756005P	Właz A15 600 H75 polimerowy	1	199,43
WŁ120600P	Właz B125 600 H90 polimerowy	1	343,81

Pokrywy teleskopowe DN250 żeliwne z włazem (b/manszety)

Nr art.	Długość [mm]	Klasa	Nazwa	Cena netto [zł/kpl.]
4703022	500	B - 12,5 T	L250 pełna	283,75
4703032	500	D - 40,0 T	L250 pełna	297,57

* W komplecie: pokrywa żeliwna, rura teleskopowa

Pokrywy teleskopowe DN250 żeliwne z wpustem (b/manszety)

Nr art.	Długość [mm]	Klasa	Nazwa	Cena netto [zł/kpl.]
4703072	500	B - 12,5 T	L250 z kratką	192,04
4703082	500	D - 40,0 T	L250 z kratką	200,33

* W komplecie: pokrywa żeliwna, rura teleskopowa

Pokrywy teleskopowe DN315 żeliwne z włazem (b/manszety)

Nr art.	Długość [mm]	Klasa	Nazwa	Cena netto [zł/kpl.]
4703042	500	A - 1,5 T	L315 pełna	263,03
4703052	500	B - 12,5 T	L315 pełna	327,96
4703062	500	D - 40,0 T	L315 pełna	355,59

* W komplecie: pokrywa żeliwna, rura teleskopowa

Pokrywy teleskopowe DN315 żeliwne z wpustem (b/manszety)

Nr art.	Długość [mm]	Klasa	Nazwa	Cena netto [zł/kpl.]
4703092	500	A - 1,5 T	L315 kratka	265,79
4703102	500	B - 12,5 T	L315 kratka	355,59
4703112	500	D - 40,0 T	L315 kratka	383,22

* W komplecie: pokrywa żeliwna, rura teleskopowa

Pokrywy teleskopowe DN425 żeliwne z włazem i manszetą

Nr art.	Długość [mm]	Klasa	Nazwa	Cena netto [zł/kpl.]
NR4703565	500	A - 1,5 T	L400 pełna	566,45
NR4703567	500	B - 12,5 T	L400 pełna	594,08
NR4703570	500	D - 40,0 T	L400 pełna	621,71

* W komplecie: pokrywa żeliwna, rura teleskopowa

Pokrywy teleskopowe DN425 żeliwne z wpustem i manszetą

Nr art.	Długość [mm]	Klasa	Nazwa	Cena netto [zł/kpl.]
NR4703580	500	A - 1,5 T	L400 pełna	594,08
NR4703581	500	B - 12,5 T	L400 pełna	621,71
NR4703583	500	D - 40,0 T	L400 pełna	649,34

* W komplecie: pokrywa żeliwna, rura teleskopowa

Włazy kanalizacyjne na rurę 250

Nr art.	Typ	Rodzaj	Waga	Cena netto [zł/szt.]
WŁ12025K	B125	kwadrat	12,0	228,49
WŁ400250K	D400	kwadrat	13,0	234,65

Wpusty uliczne na rurę 250

Nr art.	Typ	Rodzaj	Waga	Cena netto [zł/szt.]
WP120250K	B125	kwadrat	12,5	323,40
WP400250K	D400	kwadrat	14,0	370,34

Wpusty uliczne na rurę 315

Nr art.	Typ	Rodzaj	Waga	Cena netto [zł/szt.]
WP050315K	A15	kwadrat	12,0	135,77
WP120315K	B125	kwadrat	24,0	219,17
WP400315K	D400	kwadrat	28,0	252,95

Włazy kanalizacyjne na rurę 315

Nr art.	Typ	Rodzaj	Waga	Cena netto [zł/szt.]
WŁ050315K	A15	kwadrat	12,0	135,77
WŁ120315K	B125	kwadrat	24,0	210,17
WŁ400315K	D400	kwadrat	28,0	252,95

Włazy

Nr art.	Typ	Rodzaj	Waga	Cena netto [zł/szt.]
WŁ0506005	A15	DN600 H50	60,0	353,38
WŁ1206008	B125	DN600 H80	80,0	725,36
WŁ1206009	B125	DN600 H80 żel-bet	80,0	641,67
WŁ2506008	C250	DN600 H80	95,0	762,56
WŁ2506005	C250	DN600 H80 żel-bet	80,0	738,38
WŁ4006011	D400	DN600 H115	125,0	911,35
WŁ4006011B	D400	DN600 H115 żel-bet	125,0	827,66

Wpusty

Nr art.	Typ	Rodzaj	Waga	Cena netto [zł/szt.]
WP40B67113/4	D400	400/600 H100 3/4 kolnierza	78,0	790,46
WP40B67114/4	D400	400/600 H100 4/4 kolnierza	87,0	827,66

CECHY I ZALETY: Axedo

- WYPRODUKOWANE ZGODNIE Z NORMĄ PN-EN 13598-2:2020-11 ORAZ PN-EN 476:2012,
- SZYBKA I ŁATWA INSTALACJA,
- CAŁKOWITA SZCZELNOŚĆ,
- GŁĘBOKOŚĆ ZAKOPIU DO 6 METRÓW,
- MOŻLIWOŚĆ ZMIANY KIERUNKU RUROCIĄGU DO 7,5° W KAŻDYM Z KIERUNKÓW,
- DOSKONAŁA ODPORNOŚĆ POLIPROPYLENU NA:
 - TEMPERATURY (-20°C +95°C),
 - DZIAŁANIE ŚRODKÓW CHEMICZNYCH,
 - UDERZENIA,
 - KOROZJĘ NAPRĘŻENIOWĄ,
- ODPORNOŚĆ, DZIĘKI SYSTEMOWEMU OŻEBROWANIU, NA WYPÓR WÓD GRUNTOWYCH ORAZ DOSTOSOWANIE, DO ZMIENNYCH WARUNKÓW KLIMATYCZNYCH,
- DOPŁYWY I ODPLÝWY W ŚREDNICACH DO $\varnothing 400$,



	H (mm)	A (mm)	B (mm)	C (mm)
160	383,7	158,4	193,3	32,0
200	425,7	158,4	235,3	32,0
250	478,3	158,4	287,9	32,0
315	546,7	158,4	356,3	32,0
400	636,3	158,4	445,9	32,0



**Kinety studni rewizyjnej dla rury wznoszącej
Ø 600 korugowanej**

	Nr art.	DN [mm]	Opis	szt.	Cena netto [zł/szt.]
	4701063	600 RK/160 RG	przelotowa	1	753,40
	4701064	600 RK/200 RG	przelotowa	1	831,34
	4701087	600 RK/250 RG	przelotowa	1	1 026,19
	4701088	600 RK/315 RG	przelotowa	1	1 091,13
	4701089	600 RK/400 RG	przelotowa	1	1 208,04
	4701080	600 RK/160 RG	zbiorcza	1	909,28
	4701081	600 RK/200 RG	zbiorcza	1	1 026,19
	4701082	600 RK/250 RG	zbiorcza	1	1 363,92
	4701084	600 RK/315 RG	zbiorcza	1	1 753,61

Rury wznoszące Ø 600 (korugowane, bez kielicha)

	Nr art.	Średnica [mm]	Długość [mm]	m	Cena netto [zł/mb]
	IN8600600	ø 600	6000	1	346,31

Uszczelka do rury korugowanej 600

	Nr art.	Średnica [mm]	szt.	Cena netto [zł/szt.]
	IN8700014	600	1	93,53

Stożek odciążający

	Nr art.	DN [mm]	szt.	Cena netto [zł/szt.]
	PI50200726	Stożek odciążający T3 615/700	1	285,77

Teleskop z uszczelką

	Nr art.	DN [mm]	szt.	Cena netto [zł/kpl.]
	KA8560010	Teleskop 600	1	478,80



Kąt wycięcia 7,5° w każdym kierunku

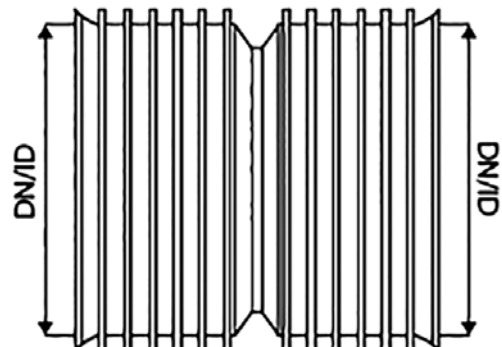
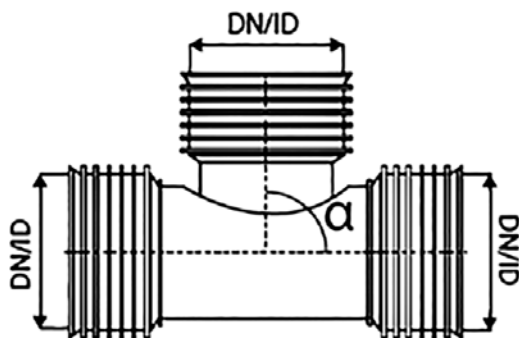
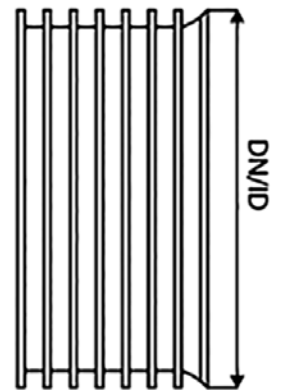
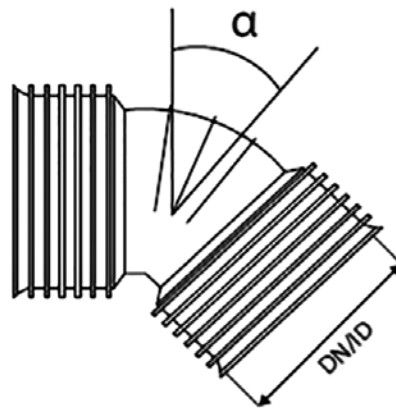
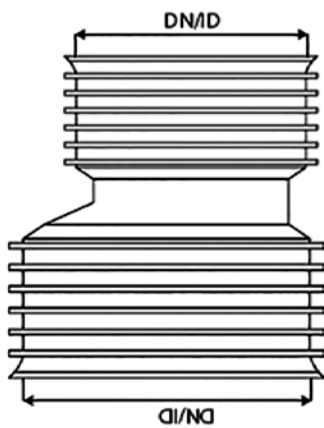

Rura kanalizacji zewnętrznej korugowana PP SN8 z kielichem

Wymiar nominalny odniesiony do średnicy wewnętrznej



Nr art.	DN/ID [mm]	L [mm]	Ilość w opakowaniu paleta	Cena netto [zł/mb]
	160	3000	1	35,47
	160	6000	1	33,40
	200	3000	1	55,42
	200	6000	1	50,25
	250	3000	1	94,59
	250	6000	1	85,72
	300	3000	1	131,53
	300	6000	1	115,28
	400	3000	1	214,29
	400	6000	1	189,17
	500	3000	1	387,21
	500	6000	1	339,92
	600	3000	1	588,20
	600	6000	1	509,87
	800	3000	1	889,69
	800	6000	1	786,98
	1000	3000	1	1 552,53
	1000	6000	1	1 383,31

Rura kanalizacji zewnętrznej korugowana PP SN8 (bez kielicha)

Wymiar nominalny odniesiony do średnicy wewnętrznej



Nr art.	DN/ID [mm]	L [mm]	Ilość w opakowaniu paleta	Cena netto [zł/mb]
	160	6000	1	31,04
	200	6000	1	47,29
	250	6000	1	82,76
	300	6000	1	109,36
	400	6000	1	175,87
	500	6000	1	316,27
	600	6000	1	484,75
	800	6000	1	886,74
	1000	6000	1	1 655,24

Nasuwka rury korugowanej PP

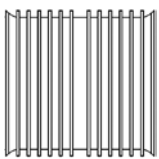

DN/ID	Cena katalogowa [zł/szt.]
160	35,80
200	60,44
250	99,48
300	224,78
400	353,11
500	559,21
600	899,20
800	1762,23
1000	2898,84

Uszczelka rury korugowanej PP



DN/ID	Cena katalogowa [zł/szt.]
160	3,87
200	9,10
250	12,99
300	20,07
400	50,05
500	95,55
600	134,95
800	266,11
1000	524,33

**Rury kanalizacyjne wewnętrzne z PP
ITB-KOT-2018/0366 wydanie 2**



Nr art.	D [mm]	Grubość ścianki [mm]	L [m]	Ilość wiązka / paleta	Cena netto [zł/szt.]
5100018P-4	40	1,8	0,15	100	2,78
5100020P-4	40	1,8	0,25	100	4,46
5101020P-4	40	1,8	0,50	20 / 400	6,20
5102020P-4	40	1,8	1,00	20 / 400	10,64
5103010P-4	40	1,8	2,00	20 / 400	19,94
5104009P-4	40	1,8	3,00	20 / 400	28,65

**Rury kanalizacyjne wewnętrzne z PP
ITB-KOT-2018/0366 wydanie 2**



Nr art.	D [mm]	Grubość ścianki [mm]	L [m]	Ilość wiązka / paleta	Cena netto [zł/szt.]
5100017P-4	50	1,8	0,15	100	4,28
5100030P-4	50	1,8	0,25	60	5,14
5100130P-4	50	1,8	0,315	60	5,46
5101030P-4	50	1,8	0,50	20 / 240	7,17
5102030P-4	50	1,8	1,00	20 / 240	12,02
5103020P-4	50	1,8	2,00	20 / 240	21,45
5104010P-4	50	1,8	3,00	20 / 240	31,66

**Rury kanalizacyjne wewnętrzne z PP
ITB-KOT-2018/0366 wydanie 2**



Nr art.	D [mm]	Grubość ścianki [mm]	L [m]	Ilość wiązka / paleta	Cena netto [zł/szt.]
5100016P-4	75	1,9	0,15	50	7,81
5100040P-4	75	1,9	0,25	40	8,28
5100140P-4	75	1,9	0,315	30	10,04
5101040P-4	75	1,9	0,50	20 / 180	11,43
5102040P-4	75	1,9	1,00	20 / 180	16,96
5102140P-4	75	1,9	1,50	20 / 180	25,61
5103030P-4	75	1,9	2,00	20 / 180	30,69
5104020P-4	75	1,9	3,00	20 / 180	44,64

**Rury kanalizacyjne wewnętrzne z PP
ITB-KOT-2018/0366 wydanie 2**



Nr art.	D [mm]	Grubość ścianki [mm]	L [m]	Ilość wiązka / paleta	Cena netto [zł/szt.]
5100015P-4	110	2,7	0,15	20	10,25
5100050P-4	110	2,7	0,25	15	13,21
5100150P-4	110	2,7	0,315	15	15,61
5101050P-4	110	2,7	0,50	20 / 80	20,42
5102050P-4	110	2,7	1,00	20 / 80	29,01
5102150P-4	110	2,7	1,50	20 / 80	46,64
5103040P-4	110	2,7	2,00	20 / 80	49,97
5104030P-4	110	2,7	3,00	20 / 80	86,09
5107040P-4	110	2,7	6,00	48 / 48	171,74



gwarancja pełnej szczelności montażu w temperaturach poniżej -10°C



zwiększona sztywność obwodowa rur w porównaniu do tradycyjnych systemów kanalizacyjnych



możliwość inspekcji systemu, do kontroli wykonanych prac lub lokalizacji zatorów



wysoka redukcja hałasu z systemu potwierdzona badaniami w Instytucie Fraunhofera w Stuttgarcie



miarka docięcia montażowego odcinka rury

Kolano 15°

	Nr art.	DN [mm]	Ilość w opakowaniu	Cena netto [zł/szt.]
	5606020	40	50	4,16
	5606030	50	40	3,47
	5606040	75	20	8,70
	5606050	110	35	10,72

Kolano 30°

	Nr art.	DN [mm]	Ilość w opakowaniu	Cena netto [zł/szt.]
	5607020	40	50	3,82
	5607030	50	40	3,47
	5607040	75	20	8,90
	5607050	110	35	10,50

Kolano 45°

	Nr art.	DN [mm]	Ilość w opakowaniu	Cena netto [zł/szt.]
	5608020	40	50	3,82
	5608030	50	40	3,47
	5608040	75	15	9,20
	5608050	110	35	11,50

Kolano 67°

	Nr art.	DN [mm]	Ilość w opakowaniu	Cena netto [zł/szt.]
	5609010	40	20	3,82
	5609020	50	40	3,52
	5609030	75	50	10,40
	5609040	110	25	11,90

Kolano 87°

	Nr art.	DN [mm]	Ilość w opakowaniu	Cena netto [zł/szt.]
	5610020	40	50	3,82
	5610030	50	40	3,52
	5610040	75	15	9,40
	5610050	110	25	12,30

Kolano nastawne (0-30°)

	Nr art.	DN [mm]	Ilość w opakowaniu	Cena netto [zł/szt.]
	5610004	110	35	91,19

Trójnik 45°

	Nr art.	DN [mm]	Ilość w opakowaniu	Cena netto [zł/szt.]
	5601020	40 x 40	20	6,62
	5601030	50 x 40	20	7,76
	5601040	50 x 50	20	7,37
	5601050	75 x 50	50	11,88
	5601060	75 x 75	8	12,37
	5601070	110 x 50	27	13,36
	5601080	110 x 75	20	24,26
	5601090	110 x 110	12	20,66

Trójnik 67°

	Nr art.	DN [mm]	Ilość w opakowaniu	Cena netto [zł/szt.]
	5602010	40 x 40	50	7,70
	5602020	50 x 40	20	7,91
	5602030	50 x 50	20	7,55
	5602040	75 x 50	20	15,77
	5602050	75 x 75	25	10,61
	5602060	110 x 50	27	13,36
	5602070	110 x 75	20	32,74
	5602080	110 x 110	14	18,31

Trójnik 87°

	Nr art.	DN [mm]	Ilość w opakowaniu	Cena netto [zł/szt.]
	5603020	40 x 40	20	5,46
	5603030	50 x 40	15	8,00
	5603040	50 x 50	20	5,87
	5603050	75 x 50	50	15,75
	5603060	75 x 75	10	11,53
	5603070	110 x 50	28	14,23
	5603080	110 x 75	20	24,26
	5603090	110 x 110	17	18,43

Czwórnik 67°

	Nr art.	DN [mm]	Ilość w opakowaniu	Cena netto [zł/szt.]
	5604010	50 x 50	20	57,30
	5604020	75 x 75	20	85,32
	5604030	110 x 50	20	63,68
	5604040	110 x 75	20	82,77
	5604050	110 x 110	10	73,86

Czwórnik 90°



Nr art.	DN [mm]	Ilość w opakowaniu	Cena netto [zł/szt.]
5604060	110 x 110	10	78,96

Czyszczak



Nr art.	DN [mm]	Ilość w opakowaniu	Cena netto [zł/szt.]
5615010	50	25	10,31
5615020	75	20	24,26
5615030	110	15	52,50

Czwórnik dwupłaszczyznowy 67°



Nr art.	DN [mm]	Ilość w opakowaniu	Cena netto [zł/szt.]
5605010	110 x 110	10	123,52

Złączka PP/Żeliwo (traper)



Nr art.	DN [mm]	Ilość w opakowaniu	Cena netto [zł/szt.]
5621010	50	6	16,98
5621020	75	8	18,19
5621030	110	6	21,83

Nasuwka



Nr art.	DN [mm]	Ilość w opakowaniu	Cena netto [zł/szt.]
5611020	40	25	5,60
5611030	50	25	6,20
5611040	75	10	10,06
5611050	110	48	9,83

Napowietrzacz



Nr art.	DN [mm]	Ilość w opakowaniu	Cena netto [zł/szt.]
5617010	50	10	20,37
5617020	75	10	19,40
5617030	110	5	30,32

Złączka dwukielichowa



Nr art.	DN [mm]	Ilość w opakowaniu	Cena netto [zł/szt.]
5612020	40	25	5,34
5612030	50	50	6,20
5612040	75	10	10,35
5612050	110	48	10,80

Wywiewka



Nr art.	DN [mm]	Ilość w opakowaniu	Cena netto [zł/szt.]
5616010	50	5	13,47
5616020	75	5	16,38
5616030	110	2	18,68
5616040	160	5	40,12

Redukcja



Nr art.	DN [mm]	Ilość w opakowaniu	Cena netto [zł/szt.]
5613010	50 x 40	25	3,44
5613020	75 x 50	10	5,89
5613030	110 x 50	20	10,97
5613030K	110 x 50	20	7,87
5613040	110 x 75	5	13,34

Uchwyt do rur pojedynczy z kołkiem PP



Nr art.	DN [mm]	Ilość w opakowaniu	Cena netto [zł/szt.]
5618040	32	20	3,04
5618050	50	20	3,89
5618060	75	20	4,62
5618070	110	20	5,11

Korek



Nr art.	DN [mm]	Ilość w opakowaniu	Cena netto [zł/szt.]
5614010	40	250	2,67
5614020	50	150	3,47
5614030	75	20	3,64
5614040	110	20	5,22

BISMAT 1000



Nr art.	DN [mm]	Ilość w opakowaniu	Cena netto [zł/szt.]
5619270	110	1	207,90

Rury kanalizacji wewnętrznej białej

	Nr art.	D [mm]	e [mm]	L [mm]	Ilość w opakowaniu	Cena netto [zł/szt.]
	5100112-4	32	1,8	0,25	100	4,02
	5100111-4	32	1,8	0,315	100	4,30
	5101011-4	32	1,8	0,50	50	5,01
	5102011-4	32	1,8	1,00	10	9,01
	5102012-4	32	1,8	2,00	10	14,78

Kolano

	Nr art.	DN [mm]	Kąt	Ilość w opakowaniu	Cena netto [zł/szt.]
	5605011	32	15°	10	3,62
	5607011	32	30°	10	3,61
	5608011	32	45°	10	3,61
	5609000	32	67°	10	3,61
	5610011	32	90°	10	3,61

Kolano nastawne (0° - 90°)

	Nr art.	DN [mm]	Ilość w opakowaniu	Cena netto [zł/szt.]
	5610005	32	25	16,94
	5610006	40	10	14,11
	5610007	50	1	18,41
	5610008	75	1	25,77
	5610009	110	1	55,23

Trójnik

	Nr art.	DN [mm]	Kąt	Ilość w opakowaniu	Cena netto [zł/szt.]
	5601011	32x32	45°	50	6,30
	5602009	32x32	67°	50	6,30
	5603011	32x32	87°	50	6,30

Trójnik nastawny (50° - 80°)

	Nr art.	DN [mm]	Ilość w opakowaniu	Cena netto [zł/szt.]
	5602008	32x32	10	6,75

Redukcja

	Nr art.	DN [mm]	Kąt	Ilość w opakowaniu	Cena netto [zł/szt.]
	5613008	50 x 32	90°	10	6,05
	5613009	50 x 32	Prosta	10	4,98

Nasuwka

	Nr art.	DN [mm]	Ilość w opakowaniu	Cena netto [zł/szt.]
	5611011	32	100	4,90

Korek

	Nr art.	DN [mm]	Ilość w opakowaniu	Cena netto [zł/szt.]
	5614001	32	20	2,45

RURY PE80 PN8 SDR 17 PN-EN 12201-2+A1:2013-12



Nr art.	DN [mm]	Grubość ścianki [mm]	L [m]	Cena netto [zł/mb]
2120030M4	32	2,0	50	3,78
2120040M4	32	2,0	100	3,78
2120041M4	32	2,0	150	3,78
2120050M4	40	2,4	50	5,68
2120060M4	40	2,4	100	5,68
2120061M4	40	2,4	150	5,68
2120062M4	40	2,4	200	5,68
2120070M4	50	3,0	50	8,57
2120080M4	50	3,0	100	8,57
2120090M4	63	3,8	50	13,61
2120100M4	63	3,8	100	13,61

RURY PE80 PN 12,5 SDR 11 PN-EN 12201-2+A1:2013-12



Nr art.	DN [mm]	Grubość ścianki [mm]	L [m]	Cena netto [zł/mb]
2110020M4	20	2,0	100	2,83
2110030M4	25	2,3	50	3,20
2110040M4	25	2,3	100	3,20
2110041M4	25	2,3	200	3,20
2110050M4	32	3,0	50	5,24
2110060M4	32	3,0	100	5,24
2110061M4	32	3,0	200	5,24
2110062M4	32	3,0	300	5,24
2110070M4	40	3,7	50	8,00
2110080M4	40	3,7	100	8,00
2110081M4	40	3,7	150	8,00
2110083M4	40	3,7	200	8,00
2110082M4	40	3,7	300	8,00
2110090M4	50	4,6	50	12,43
2110100M4	50	4,6	100	12,43
2110101M4	50	4,6	150	12,43
2110110M4	63	5,8	50	19,70
2110120M4	63	5,8	100	19,70

RURY PE80 PN10 SDR 13,6 PN-EN 12201-2+A1:2013-12



Nr art.	DN [mm]	Grubość ścianki [mm]	L [m]	Cena netto [zł/mb]
2150005M4	25	2,0	100	3,26
2150006M4	25	2,0	200	3,26
2150009M4	32	2,4	50	4,48
2150010M4	32	2,4	100	4,48
2150020M4	32	2,4	200	4,48
2150021M4	32	2,4	300	4,48
2150029M4	40	3,0	50	6,73
2150030M4	40	3,0	100	6,73
2150031M4	40	3,0	150	6,73
2150040M4	40	3,0	200	6,73
2150042M4	40	3,0	300	6,73
2150051M4	50	3,7	50	10,18
2150050M4	50	3,7	100	10,18
2150052M4	50	3,7	150	10,18
2150061M4	63	4,7	50	16,22
2150060M4	63	4,7	100	16,22
2150061M42	75	5,6	50	22,90
2150061M43	75	5,6	100	22,90

Studzienki wodomierzowe



Nr art.	Wymiar	Cena netto [zł/szt.]
WDE041401	Studnia wodomierzowa EP+ DN400 H1400 standard	1 175,00
WDE041402	Studnia wodomierzowa EP+ DN400 H1400 premium	1 390,00
WDE051401	Studnia wodomierzowa EP+ DN500 H1400 standard	1 350,00
WDE061560	Studnia wodomierzowa EP+ DN600 H1560 standard	2 182,00
WDE101016	Studnia wodomierzowa EP+ DN1000 H1600	1 705,00
WDE101018	Studnia wodomierzowa EP+ DN1000 H1800	1 750,00
WDE101216	Studnia wodomierzowa EP+ DN1200 H1600	1 750,00
WDE101218	Studnia wodomierzowa EP+ DN1200 H1800	1 792,00

Rury PE 100, PN 10, SDR 17, Niebieska lub czarna z niebieskimi paskami PN-EN 12201-2+A1:2013-12

Nr art.	DN [mm]	Grubość ścianki [mm]	L [m]	Cena netto [zł/mb]
2150012M4	32	2,0	50	4,01
2150011M4	32	2,0	100	4,01
2150013M4	32	2,0	200	4,01
2150033M4	40	2,4	50	5,96
2150032M4	40	2,4	100	5,96
2150035M4	40	2,4	150	5,96
2150034M4	40	2,4	200	5,96
2150054M4	50	3,0	50	9,14
2150053M4	50	3,0	100	9,14
2150055M4	50	3,0	200	9,14
2150063M4	63	3,8	50	14,52
2150062M4	63	3,8	100	14,52
2150070M4	75	4,5	100	20,48
2150080M4	90	5,4	50	27,34
2150081M4	90	5,4	12	27,34
2150100M4	110	6,6	12	40,59
2150101M4	110	6,6	50	40,59
2150110M4	125 *	7,4	12	51,97
2150120M4	140 *	8,3	12	66,23
2150130M4	160 *	9,5	12	85,25
2150140M4	180 *	10,7	12	108,86
2150150M4	200 *	11,9	12	134,33
2150160M4	225 *	13,4	12	169,99
2150170M4	250 *	14,8	12	208,88
2150180M4	280 *	16,6	12	261,53
2150190M4	315 *	18,7	12	331,16
2150200M4	355 *	21,1	12	424,56
2150210M4	400 *	23,7	12	543,44

Rury PE 100, PN 16, SDR 11, Niebieska lub czarna z niebieskimi paskami PN-EN 12201-2+A1:2013-12

Nr art.	DN [mm]	Grubość ścianki [mm]	L [m]	Cena netto [zł/mb]
2160007M4	32	3,0	100	5,57
2160008M4	40	3,7	100	8,68
2160009M4	50	4,6	100	13,35
2160010M4	63	5,8	100	21,26
2160011M4	75	6,8	100	29,82
2160012M4	90	8,2	50	40,59
2160013M4	90	8,2	12	40,59
2160014M4	110	10,0	12	60,12
2160015M4	110	10,0	50	60,12
2160016M4	125 *	11,4	12	78,29
2160017M4	140 *	12,7	12	98,16
2160018M4	160 *	14,6	12	128,22
2160019M4	180 *	16,4	12	162,69
2160020M4	200 *	18,2	12	199,37
2160021M4	225 *	20,5	12	253,38
2160022M4	250 *	22,7	12	312,48
2160023M4	280 *	25,4	12	390,60
2160024M4	315 *	28,6	12	497,59
2160025M4	355 *	32,2	12	630,05
2160026M4	400 *	36,3	12	801,57

**RURY PE100 RC PN10 SDR17
Niebieska lub czarna z niebieskimi paskami**

Nr art.	DN [mm]	Grubość ścianki [mm]	L [m]	Cena netto [zł/mb]
2150011RC	32	2,0	100	4,56
2150030RC	40	2,4	100	6,22
2150053RC	50	3,0	100	9,20
2150065RC	63	3,8	100	14,51
2150070RC	75	4,5	100	20,26
2150080RC	90	5,4	50	26,10
2150083RC	90	5,4	100	26,10
2150081RC	90	5,4	12	26,10
2150100RC	110	6,6	12	39,90
2150101RC	110	6,6	50	39,90
2150110RC	125	7,4	12	44,31
2150130RC	160	9,5	12	72,63
2150150RC	200	11,9	12	114,15
2150160RC	225	13,4	12	145,60
2150170RC	250	14,8	12	178,40

**RURY PE100 RC PN16 SDR11
Niebieska lub czarna z niebieskimi paskami**

Nr art.	DN [mm]	Grubość ścianki [mm]	L [m]	Cena netto [zł/mb]
2160007RC	32	3,0	100	6,02
2160008RC	40	3,7	100	8,88
2160009RC	50	4,6	100	13,46
2160010RC	63	5,8	100	21,08
2160011RC	75	6,8	100	29,97
2160013RC	90	8,2	12	35,61
2160014RC	110	10,0	12	49,68
2160016RC	125	11,4	12	64,70
2160018RC	160	14,6	12	108,92
2160020RC	200	18,2	12	172,06
2160021RC	225	20,5	12	217,38
2160022RC	250	22,7	12	274,38

Taśma lokalizacyjna z wkładką metalową

Nr art.	Opis	Cena netto [zł/szt.]
2900020	Taśma lok. 100mb wkł. metal, szer. 20cm niebieska	152,85
2900021	Taśma lok. 100mb wkł. met. nadr. "UWAGA WODOCIĄG" niebieska	152,85
2900022	Taśma lok. 100mb wkł. met. nadr. "KANALIZACJA" brąz	152,85
2900030	Taśma lok. 100mb wkł. met. żółta GAZ szer. 20cm	152,85

Taśma lokalizacyjna

Nr art.	Opis	Cena netto [zł/szt.]
2900010	Taśma lok. 100mb, szer.20cm	109,54

Rura gazowa PE HD100 SDR11



Nr art.	Opis	Cena netto [zł/mb]
2181005	25x3,0 RC 300m	4,01
2181006	32x3,0 RC 200m	4,86
2181007	40x3,7 RC 150m	7,49
2181008	50x4,6 RC 100m	12,63
2181010	63x5,8 RC 100m	20,11

Rura gazowa PE HD100 SDR17



Nr art.	Opis	Cena netto [zł/mb]
2191011	90x5,4 RC 12m	25,76
2191012	110x6,6 RC 12m	38,42
2191013	125x7,4 RC 12m	53,22
2191016	160x9,5 RC 12m	87,33

Kolumna przyłącza 32



Nr art.	Opis	Cena netto [zł/szt.]
GAZKP320540	1,5m gw.5/4	144,27

Podejście stalowe gaz. 32



Nr art.	Opis	Cena netto [zł/szt.]
GAZP0032001	1" preiz. 1500/500	283,85

Skrzynka gaz.



Nr art.	Opis	Cena netto [zł/szt.]
GAZSN3000ZA	300x300x150 naścienna żółta ALU	187,32

Mufa elektrooporowa równoprzelotowa SDR11



Nr art.	DN [mm]	Cena netto [zł/szt.]
2620000	20 mm	13,45
2621000	25 mm	13,65
2621001	32 mm	14,89
2621002	40 mm	15,16
2621003	50 mm	22,09
2621004	63 mm	24,48
2621005	75 mm	37,28
2621010	90 mm	43,82
2621020	110 mm	55,10
2621011	125 mm	83,20
2621022	140 mm	103,90
2621023	160 mm	107,17
2621027	200 mm	180,89
2621028	225 mm	232,40
26210272	250 mm	318,52

Mufa elektrooporowa redukcyjna SDR11



Nr art.	DN [mm]	Cena netto [zł/szt.]
2621101	25x20 mm	17,14
2621102	32x20 mm	17,80
2621103	32x25 mm	17,80
2621104	40x25 mm	23,06
2621105	40x32 mm	25,71
2621107	50x32 mm	30,32
2621108	50x40 mm	31,63
2621110	63x32 mm	39,55
2621111	63x40 mm	39,55
2621112	63x50 mm	39,55
2621113	75x50 mm	93,60
2621114	75x63 mm	73,82
2621115	90x63 mm	76,46
2621116	90x75 mm	105,46
2621117	110x63 mm	108,87
26211171	110x75 mm	125,23
2621118	110x90 mm	108,87
2621124	125x110 mm	113,17
2621119	125x90 mm	113,17
2621119	160x90 mm	259,74
2621120	160x110 mm	180,89

Kolano elektrooporowe kąt 45° SDR11

Nr art.	DN [mm]	Cena netto [zł/szt.]
2623041	20 mm 45°	33,35
2623042	25 mm 45°	34,80
2623043	32 mm 45°	35,52
2623045	40 mm 45°	43,51
2623050	50 mm 45°	55,10
2623052	63 mm 45°	62,35
2623055	75 mm 45°	97,03
2621207	90mm 45°	100,70
2621208	110mm 45°	138,42
26212081	125mm 45°	206,42
2621209	160mm 45°	311,69
2621206	225 mm 45°	1 414,89

Trójnik elektrooporowy równoprzelotowy SDR11

Nr art.	DN [mm]	Cena netto [zł/szt.]
2624003	20	34,28
2624004	25	34,28
2624005	32	35,86
2624006	40	45,48
2624007	50	57,07
2624008	63	63,54
2624010	90	106,68
2624020	110	165,51
2624015	125	229,66
2624030	160	400,34

Kolano elektrooporowe kąt 90° SDR11

Nr art.	DN [mm]	Cena netto [zł/szt.]
2623006	20 mm 90°	31,37
2623000	25 mm 90°	32,69
2623001	32 mm 90°	34,66
2623002	40 mm 90°	42,71
2623004	50 mm 90°	49,04
2623003	63 mm 90°	61,83
2623005	75 mm 90°	93,32
2623010	90 mm 90°	99,40
2623020	110 mm 90°	138,42
2623025	125 mm 90°	206,42
2623030	160 mm 90°	311,69
2623035	180 mm 90°	649,35
2623036	200 mm 90°	1 319,19

Trójnik elektrooporowy redukcyjny SDR11

Nr art.	DN [mm]	Cena netto [zł/szt.]
2624031	32/25	35,86
2624032	40/25	43,37
2624033	40/32	47,98
2624034	50/32	56,68
2624035	50/40	58,14
2624036	63/32	59,06
2624037	63/40	61,29
2624038	63/50	64,06
2624045	90/63	109,12
2624047	110/90	166,09
2624049	125/90	241,96
2624051	160/90	459,42
2624050	160/110	459,42

Zaślepka elektrooporowa SDR11

Nr art.	DN [mm]	Cena netto [zł/szt.]
2622003	20 mm	17,80
2622004	25 mm	18,18
2622005	32 mm	19,77
2622006	40 mm	21,75
2622007	50 mm	28,34
2622008	63 mm	34,66
2622010	90 mm	55,89
2622020	110 mm	72,51
2622023	160 mm	221,46
2622021	125 mm	143,54
2622022	200 mm	483,94

Trójnik elektrooporowy siodłowy z nawiertką SDR11

Nr art.	DN [mm]	Cena netto [zł/szt.]
2628002	63x32	101,24
2628004	90x40	118,64
2628005	90x32	118,64
2628006	90x63	146,32
2628007	110x32	151,60
2628008	110x40	151,60
26280081	110x63	151,60
2628014	125x32	158,19
26280087	140x32	171,37
26280100	160x32	191,14
26280090	160 x 40	191,14
26280105	180x32	191,14
26280089	200/32	197,74

Złączka prosta PE-PE



Nr art.	Wymiar [mm]	Cena netto [zł/szt.]
701 020	20	6,94
701 025	25	8,26
701 032	32	10,33
701 040	40	16,75
701 050	50	24,44
701 063	63	32,70
701 075	75	72,29
701 090	90	91,79
701 110	110	191,61

Złączka prosta redukcyjna PE-PE



Nr art.	Wymiar [mm]	Cena netto [zł/szt.]
702 025	25 x 20	7,69
702 031	32 x 20	9,98
702 032	32 x 25	9,98
702 039	40 x 25	16,29
702 040	40 x 32	16,29
702 049	50 x 32	22,60
702 050	50 x 40	22,60
702 061	63 x 32	35,57
702 062	63 x 40	33,27
702 063	63 x 50	33,27
702 074	75 x 50	69,42
702 075	75 x 63	69,42
702 089	90 x 63	99,82
702 090	90 x 75	94,08
702 110	110 x 90	189,31

Złączka PE-GW



Nr art.	Wymiar [mm]	Cena netto [zł/szt.]
703 020	20 x 1/2"	4,59
703 021	20 x 3/4"	4,59
703 024	25 x 1/2"	5,16
703 025	25 x 3/4"	5,16
703 026	25 x 1"	5,28
703 030	32 x 1/2"	6,60
703 031	32 x 3/4"	6,60
703 032	32 x 1"	6,60
703 033	32 x 1 1/4"	8,72
703 039	40 x 1"	10,56
703 040	40 x 1 1/4"	10,56
703 041	40 x 1 1/2"	10,56
703 050	50 x 1 1/2"	15,49
703 051	50 x 2"	16,98
703 062	63 x 1 1/2"	24,09
703 063	63 x 2"	21,80
703 074	75 x 2"	48,19
703 076	75 x 3"	48,19
703 075	75 x 2 1/2"	50,48
703 090	90 x 3"	60,81
703 109	110 x 3"	142,27
703 110	110 x 4"	142,27

Złączka prosta PE-GZ



Nr art.	Wymiar [mm]	Cena netto [zł/szt.]
704 020	20 x 1/2"	4,13
704 021	20 x 3/4"	4,13
704 024	25 x 1/2"	4,76
704 025	25 x 3/4"	4,76
704 026	25 x 1"	4,76
704 031	32 x 3/4"	5,97
704 032	32 x 1"	5,97
704 033	32 x 1 1/4"	6,54
704 038	40 x 3/4"	10,67
704 039	40 x 1"	10,67
704 040	40 x 1 1/4"	10,67
704 041	40 x 1 1/2"	10,67
704 049	50 x 1 1/4"	14,34
704 050	50 x 1 1/2"	14,34
704 051	50 x 2"	14,34
704 062	63 x 1 1/2"	21,23
704 063	63 x 2"	21,23
704 064	63 x 2 1/2"	21,23
704 074	75 x 2"	47,04
704 075	75 x 2 1/2"	47,04
704 076	75 x 3"	47,04
704 088	90 x 2"	68,84
704 090	90 x 3"	57,37
704 109	110 x 3"	114,74
704 110	110 x 4"	114,74

Trójnik PE PN16



Nr art.	Wymiar [mm]	Cena netto [zł/szt.]
709 020	20	9,64
709 025	25	12,16
709 032	32	15,49
709 040	40	26,16
709 050	50	35,91
709 063	63	50,48
709 075	75	105,56
709 090	90	148,01
709 110	110	293,73

Trójnik PE-GW



Nr art.	Wymiar [mm]	Cena netto [zł/szt.]
710 020	20 x 1/2"	8,03
710 021	20 x 3/4"	8,03
710 024	25 x 1/2"	9,98
710 025	25 x 3/4"	9,98
710 026	25 x 1"	10,90
710 030	32 x 1/2"	13,19
710 031	32 x 3/4"	13,19
710 032	32 x 1"	13,19
710 033	32 x 1 1/4"	16,64
710 039	40 x 1"	22,37
710 040	40 x 1 1/4"	22,37
710 041	40 x 1 1/2"	25,82
710 049	50 x 1 1/4"	35,57
710 050	50 x 1 1/2"	30,41
710 062	63 x 1 1/2"	52,78
710 063	63 x 2"	52,78
710 074	75 x 2"	94,08
710 075	75 x 2 1/2"	81,46
710 076	75 x 3"	92,94
710 090	90 x 3"	127,36
710 110	110 x 4"	228,33

Trójnik redukcyjny PE-PE-PE



Nr art.	Wymiar [mm]	Cena netto [zł/szt.]
712 025	25 x 20	11,93
712 031	32 x 20	16,98
712 032	32 x 25	15,26
712 040	40 x 32	26,39
712 049	50 x 32	35,57
712 050	50 x 40	35,57
712 061	63 x 32	51,63
712 062	63 x 40	52,78
712 063	63 x 50	48,19
712 075	75 x 63	100,97
712 090	90 x 75	164,07
712 110	110 x 90	292,58

Trójnik PE-GZ



Nr art.	Wymiar [mm]	Cena netto [zł/szt.]
711 020	20 x 1/2"	7,57
711 021	20 x 3/4"	7,57
711 024	25 x 1/2"	9,98
711 025	25 x 3/4"	9,98
711 026	25 x 1"	9,98
711 031	32 x 3/4"	12,85
711 032	32 x 1"	12,85
711 033	32 x 1 1/4"	12,85
711 039	40 x 1"	21,91
711 040	40 x 1 1/4"	21,91
711 050	50 x 1 1/2"	34,42
711 063	63 x 2"	52,78
711 074	75 x 2"	105,56
711 075	75 x 2 1/2"	91,79
711 090	90 x 3"	130,80
711 091	90 x 4"	130,80
711 110	110 x 4"	231,77

Kolano PE-PE



Nr art.	Wymiar [mm]	Cena netto [zł/szt.]
706 020	20	7,00
706 025	25	8,26
706 032	32	10,56
706 040	40	17,78
706 050	50	26,39
706 063	63	33,27
706 075	75	71,71
706 090	90	96,38
706 110	110	198,49

Kolano PE-GZ



Nr art.	Wymiar [mm]	Cena netto [zł/szt.]
707 020	20 x 1/2"	4,82
707 021	20 x 3/4"	4,82
707 024	25 x 1/2"	6,08
707 025	25 x 3/4"	5,85
707 026	25 x 1"	6,20
707 031	32 x 3/4"	7,34
707 032	32 x 1"	7,34
707 033	32 x 1 1/4"	8,15
707 039	40 x 1"	11,93
707 040	40 x 1 1/4"	11,93
707 041	40 x 1 1/2"	12,51
707 049	50 x 1 1/4"	19,85
707 050	50 x 1 1/2"	18,13
707 051	50 x 2"	19,73
707 062	63 x 1 1/2"	24,78
707 063	63 x 2"	24,78
707 075	75 x 2 1/2"	55,65
707 076	75 x 3"	57,37
707 090	90 x 3"	80,32
707 110	110 x 4"	141,13

Złącze zaciskowe kołnierzowe PN16



Nr art.	Wymiar [mm]	Cena netto [zł/szt.]
714 050	50 x 1 1/2"	53,35
714 051	50 x 2"	56,79
714 063	63 x 2"	63,10
714 075	75 x 2 1/2"	97,53
714 090	90 x 3"	120,47
714 110	110 x 4"	195,05

Kolano PE-GW



Nr art.	Wymiar [mm]	Cena netto [zł/szt.]
708 020	20 x 1/2"	5,51
708 021	20 x 3/4"	5,51
708 024	25 x 1/2"	6,88
708 025	25 x 3/4"	6,88
708 026	25 x 1"	6,88
708 030	32 x 1/2"	7,80
708 031	32 x 3/4"	7,80
708 032	32 x 1"	7,80
708 033	32 x 1 1/4"	11,47
708 039	40 x 1"	15,49
708 040	40 x 1 1/4"	15,49
708 050	50 x 1 1/2"	21,34
708 051	50 x 2"	24,09
708 063	63 x 2"	28,11
708 074	75 x 2"	59,66
708 075	75 x 2 1/2"	59,66
708 089	90 x 2 1/2"	117,03
708 090	90 x 3"	103,26
708 109	110 x 3"	177,84
708 110	110 x 4"	183,58

Zawory kulowe PE x GW PN16



Nr art.	Wymiar [mm]	Cena netto [zł/szt.]
ZAW PEGW 020	20 x 1/2"	53,93
ZAW PEGW 025	25 x 3/4"	66,55
ZAW PEGW 032	32 x 1"	75,73
ZAW PEGW 040	40 x 1 1/4"	105,56
ZAW PEGW 050	50 x 1 1/2"	119,33
ZAW PEGW 063	63 x 2"	177,84

Zawory kulowe PE x PE PN16



Nr art.	Wymiar [mm]	Cena netto [zł/szt.]
ZAW PEPE 020	20	53,93
ZAW PEPE 025	25	66,55
ZAW PEPE 032	32	75,73
ZAW PEPE 040	40	105,56
ZAW PEPE 050	50	119,33
ZAW PEPE 063	63	177,84

Korek - zaślepka



Nr art.	Wymiar [mm]	Cena netto [zł/szt.]
705 020	20	4,70
705 025	25	5,39
705 032	32	6,77
705 040	40	10,67
705 050	50	16,18
705 063	63	22,37
705 075	75	57,37
705 090	90	68,84
705 110	110	146,86

Kolano redukcyjne PE PN16



Nr art.	Wymiar [mm]	Cena netto [zł/szt.]
726 025	25 x 20	8,32
726 032	32 x 25	11,47

Rury ciśnieniowe z PVC-U, PN-EN ISO1452-2:2010 TYP: PN 10

	Nr art.	D [mm]	Grubość ścianki [mm]	L [mm]	Ilość w opakowaniu	Cena netto [zł/szt.]
	3110041-4	90	4,3	3,0	60	86,61
	3110040-4	90	4,3	6,0	60	161,91
	3110051-4	110	4,2	3,0	60	104,71
	3110050-4	110	4,2	6,0	60	194,31
	3110061-4	160	6,2	3,0	28	220,21
	3110060-4	160	6,2	6,0	28	403,05
	3110075-4	225	8,6	3,0	11	423,36
	3110070-4	225	8,6	6,0	11	793,20

Łuk ciśnieniowy PVC-U 11°

	Nr art.	DN [mm]	Cena netto [zł/szt.]
	3603010	90	33,60
	3603070	110	49,31
	3603130	160	112,42
	3603190	225	269,69

Łuk ciśnieniowy PVC-U 22°

	Nr art.	DN [mm]	Cena netto [zł/szt.]
	3603020	90	40,03
	3603080	110	56,10
	3603140	160	136,27
	3603200	225	320,54

Łuk ciśnieniowy PVC-U 30°

	Nr art.	DN [mm]	Cena netto [zł/szt.]
	3603030	90	46,49
	3603090	110	61,16
	3603150	160	154,40
	3603210	225	355,05

Łuk ciśnieniowy PVC-U 45°

	Nr art.	DN [mm]	Cena netto [zł/szt.]
	3603040	90	52,13
	3603100	110	70,30
	3603160	160	192,74
	3603220	225	431,42

Łuk ciśnieniowy PVC-U 60°

	Nr art.	DN [mm]	Cena netto [zł/szt.]
	3603050	90	68,78
	3603110	110	92,99
	3603170	160	240,35
	3603230	225	538,21

Łuk ciśnieniowy PVC-U 90°

	Nr art.	DN [mm]	Cena netto [zł/szt.]
	3603060	90	72,19
	3603120	110	98,99
	3603180	160	261,77
	3603240	225	663,02

Złączka dwukielichowa PVC-U

	Nr art.	DN [mm]	Cena netto [zł/szt.]
	3703010	90	23,66
	3703020	110	31,57
	3703030	160	82,44
	3703040	225	183,99

Nasuwka PVC-U

	Nr art.	DN [mm]	Cena netto [zł/szt.]
	3803010	90	27,57
	3803020	110	38,13
	3803030	160	85,89
	3803040	225	146,24

Uszczelki ciśnieniowe

	Nr art.	DN [mm]	Cena netto [zł/szt.]
	0112001	90	3,76
	0112002	110	4,59
	0112021	125	5,60
	0112004	160	9,18
	0112006	225	19,86

Środek poślizgowy do rur wodociągowych PVC (DYKA Lubricant)

	Nr art.	Waga	Cena netto [zł/szt.]
	4630003	250 g	30,86
	4630004	500 g	55,54
	4630002	800 g	99,18

Zasuwy kołnierzowe figury 002 PN 10 (uszczelnienie gumowe)



Nr art.	Wymiar	Waga	Cena netto [zł/szt.]
AR110050	DN50	12,5	377,27
AR110080	DN80	20,0	453,06
AR110088	DN80 (8 otw.)	20,0	453,06
AR110100	DN100	23,5	554,11
AR110150	DN150	44,5	1 025,69
AR110200	DN200	80,5	2 012,65

Zasuwy kołnierzowe figury 111 PN 10 (uszczelnienie gumowe)



Nr art.	Wymiar	Waga	Cena netto [zł/szt.]
AR120050	DN50	11,5	367,16
AR120080	DN80	17,0	442,95
AR120088	DN80 (8 otw.)	17,0	442,95
AR120100	DN100	20,5	544,00
AR120150	DN150	39,0	998,74
AR120200	DN200	67,5	1 861,07

Zasuwy bosc PN 10 (uszczelnienie gumowe)



Nr art.	Wymiar	Waga	Cena netto [zł/szt.]
AR130080	DN80	12,0	412,63
AR130100	DN100	15,5	496,85

Zasuwy gwintowane PN 10 (uszczelnienie gumowe)



Nr art.	Wymiar	Waga	Cena netto [zł/szt.]
AR140025	DN25	2,8	183,58
AR140032	DN32	2,9	217,26
AR140040	DN40	2,9	225,69
AR140050	DN50	7,1	284,63

Zasuwy kołnierzowe figury 002 SFERO PN 16



Nr art.	Wymiar	Waga	Cena netto [zł/szt.]
AR150050	DN50sfero	11,5	449,69
AR150088	DN 80 sfero	19,0	618,11
AR150100	DN 100sfero	22,0	736,01

Zasuwy kołnierzowe figury 111 SFERO PN 16



Nr art.	Wymiar	Waga	Cena netto [zł/szt.]
AR160050	DN50sfero	10,5	432,85
AR160088	DN80sfero	17,0	584,43
AR160100	DN100sfero	20,5	668,64

Zasuwy gwintowane SFERO PN 16



Nr art.	Wymiar	Waga	Cena netto [zł/szt.]
AR170025	DN25sfero	2,7	208,84
AR170032	DN32sfero	2,8	225,69
AR170040	DN40sfero	2,8	250,95
AR170050	DN50sfero	6,9	323,37

Nawiertki samonawiercające NS



Nr art.	Wymiar	Waga	Cena netto [zł/szt.]
AR210090	DN90 /5/4'	5,8	227,37
AR210110	DN 110 /5/4'	6,5	244,21
AR210160	DN160 /5/4'	7,5	281,27
AR210225	DN225 /5/4'	7,7	345,27
AR211090	DN90 /6/4'	5,7	230,74
AR211110	DN110 /6/4'	6,4	247,58
AR211160	DN160 /6/4'	7,2	284,63
AR211225	DN 225 /6/4'	8,0	348,63
AR212090	DN 90 /2'	5,6	286,32
AR212110	DN110 /2'	5,9	294,74
AR212160	DN160 /2'	7,4	320,00
AR212225	DN225 /2'	8,8	348,63

Nawiertki z zasuwą i opaską żeliwną NZ (PCV, PE) - SFERO



Nr art.	Wymiar	Waga	Cena netto [zł/szt.]
AR221090	DN90 / 32PCV/PEsfero	5,7	335,16
AR221110	DN110 / 32PCV/PE sfero	5,9	343,58
AR221160	DN160 / 32PCV/PEsfero	7,7	360,42
AR221225	DN225 / 32PCV/PEsfero	9,1	377,27
AR222090	DN90 / 40PCV/PEsfero	5,7	343,58
AR222110	DN110 / 40PCV/PEsfero	5,8	352,00
AR222160	DN160 / 40PCV/PE sfero	7,6	368,84
AR222225	DN225 / 40PCV/PEsfero	9,0	385,69
AR223090	DN90 / 50PCV/PE sfero	10,0	407,58
AR223110	DN110 / 50PCV/PE sfero	10,2	416,00
AR223160	DN160 / 50PCV/PE sfero	12,0	432,85
AR223225	DN225 / 50PCV/PEsfero	13,4	449,69

Nawiertki z zasuwą i opaską stalową NZE (ZEL, AC, STAL, PE, PCV) - SFERO

Nr art.	Wymiar	Waga	Cena netto [zł/szt.]
AR230065	DN 65/32 (75- 83 mm)	4,6	419,37
AR230090	DN 90/32 (89-104 mm)	4,7	422,74
AR230110	DN 110/32 (107-130 mm)	4,7	426,11
AR230125	DN 125/32 (124-144 mm)	4,9	429,48
AR230126	DN 125/32 (148-160 mm) AC	4,9	431,16
AR230160	DN 160/32 (159-178 mm)	5,4	432,85
AR230180	DN 180/32 (179-200 mm)	5,6	436,21
AR230225	DN 225/32 (219-238 mm)	6,2	439,58
AR230250	DN 250/32 (248-275 mm)	6,3	442,95
AR230251	DN 250/32 (287-307 mm) AC	6,5	444,63
AR230315	DN 315/32 (315-327 mm)	6,5	446,32
AR230316	DN 315/32 (345-371 mm) AC	6,5	448,00
AR231065	DN 65/40 (75 - 83 mm)	4,6	422,74
AR231090	DN 90/40 (89 -104 mm)	4,7	426,11
AR231110	DN 110/40 (107-130 mm)	4,7	429,48
AR231125	DN 125/40 (124-144 mm)	4,9	432,85
AR231126	DN 125/40 (148-160 mm) AC	4,9	434,53
AR231160	DN 160/40 (159-178 mm)	5,4	436,21
AR231180	DN 180/40 (179-200 mm)	5,6	439,58
AR231225	DN 225/40 (219-238 mm)	6,2	442,95
AR231250	DN 250/40 (248-275 mm)	6,3	446,32
AR231251	DN 250/40 (287-307 mm) AC	6,5	448,00
AR231315	DN 315/40 (315-327 mm)	6,5	449,69
AR231316	DN 315/40 (345-371 mm) AC	6,5	451,37
AR232090	DN 90/50 (89-104 mm)	8,7	473,27
AR232110	DN 110/50 (107-130 mm)	8,9	476,63
AR232125	DN 125/50 (124-144 mm)	8,9	480,00
AR232126	DN 125/50 (148-160 mm) AC	9,1	481,69
AR232160	DN 160/50 (159-178 mm)	9,1	483,37
AR232180	DN 180/50 (179-200 mm)	9,6	486,74
AR232225	DN 225/50 (219-238 mm)	9,8	490,11
AR232250	DN 250/50 (248-275 mm)	10,4	493,48
AR232251	DN 250/50 (287-307 mm) AC	10,5	495,16
AR232315	DN 315/50 (315-327 mm)	10,7	496,85
AR232316	DN 315/50 (345-371 mm) AC	10,7	498,53

Hydranty przeciwpożarowe DN 80

Nr art.	Wymiar	Waga	Cena netto [zł/szt.]
AR310215P	Hydrant nadziemny L2150 malowany proszkowo	36,5	922,00
AR310230P	Hydrant nadziemny L 2300 malowany proszkowo	40,5	906,11
AR320125P	Hydrant podziemny L1250 malowany proszkowo	28,2	768,01
AR330000	Nasada aluminiowa		33,68
AR330001	Nasada tworzywo		30,32
AR330002	Pokrywa nasady hydr. (żeliwna)		37,05
AR330003	Pokrywa nasady hydr. (tworzywo)		18,53

Obudowy sztywne do zasuw i nawiertek

Nr art.	Wymiar	Waga	Cena netto [zł/szt.]
AR410032	DN25, 32, 40, 50	3,1	52,21
AR410080	DN80	3,1	52,21
AR410150	DN100,150	3,1	52,21
AR410200	DN200	3,1	72,42
AR410063	Klucz imer	2,7	48,84

Obudowy teleskopowe do zasuw i nawiertek

Nr art.	Wymiar	Waga	Cena netto [zł/szt.]
AR420032	DN25, 32, 40, 50	3,7	102,74
AR420081	DN80	3,7	102,74
AR420150	DN100,150	3,7	102,74
AR420200	DN200	3,7	122,95
AR420063	Tele. klucz imer	3,3	99,37

Kółka do zasuw

Nr art.	Wymiar	Waga	Cena netto [zł/szt.]
AR430160	fi 160 do zasuw DN 25,32,40,50	0,4	37,05
AR430280	fi 200 do zasuw DN 80	0,7	47,16
AR430255	fi 250 do zasuw DN 100,150	0,9	58,95
AR430322	fi 320 do zasuw DN 200	1,1	79,16

Skrzynki wodociągowe

Nr art.	Wymiar	Waga	Cena netto [zł/szt.]
AR510080	Nawiertki	3,1	55,58
AR510100	Zasuwy 100	5,1	74,11
AR510150	Zasuwyh = 270W fig 4056	13,0	117,90
AR510155	Zasuwyh = 270 Gfig 4056	13,0	117,90
AR510300	Hydrantowa fig 4055	32,1	353,69

Skrzynki wodociągowe korpus PEHD

Nr art.	Wymiar	Waga	Cena netto [zł/szt.]
AR520150	Zasuwyh = 270 z PEHD W fig 4056	3,8	85,90
AR520155	Zasuwyh = 270 z PEHD G fig 4056	3,8	85,90
AR520300	Hydrantowa z PEHD fig 4055	10,0	249,26

Podkładki PEHD pod skrzynki



Nr art.	Wymiar	Waga	Cena netto [zł/szt.]
AR530001	Pod skrzynkę zasuwę/nawiertki	0,9	21,89
AR530002	Pod skrzynkę hydrantową	1,8	33,68

Łączniki rurowo – kołnierzowe RK – SFERO



Nr art.	Wymiar	Waga	Cena netto [zł/szt.]
AR610088	DN 80 (88 - 102 mm)	9,3	318,32
AR610100	DN 100 (108 - 124 mm)	11,6	368,84
AR610150	DN 150 (159 - 179 mm)	17,5	486,74
AR610200	DN 200 (219 - 238 mm)	24,2	419,37

Łączniki rurowo – rurowe RR – SFERO



Nr art.	Wymiar	Waga	Cena netto [zł/szt.]
AR620088	DN 80 (88 - 102 mm)	7,7	276,21
AR620100	DN 100 (108 - 124 mm)	8,5	309,90
AR620150	DN 150 (159 - 179 mm)	13,0	400,84
AR620200	DN 200 (219 - 238 mm)	15,6	545,69

Króćce jednokołnierzowe FW



Nr art.	Wymiar	Waga	Cena netto [zł/szt.]
AR710050	DN 50	2,6	50,53
AR710090	DN 80 (8 otw.)	4,1	64,00
AR710110	DN 100	4,9	75,79
AR710160	DN 150	9,4	133,05
AR710200	DN 200/200	15,0	215,58
AR710225	DN 200/225	15,0	217,26
AR710250	DN 250/250	22,0	385,69
AR710280	DN 250/280	25,0	387,37
AR710315	DN 300	31,0	545,69
AR710400	DN 400	46,0	958,32
AR710500	DN 500	89,0	1 480,43

Kolana kołnierzowe stopowe N



Nr art.	Wymiar	Waga	Cena netto [zł/szt.]
AR810080	DN 80	15,4	176,84
AR810088	DN 80 (8 otw.)	15,4	176,84
AR810100	DN 100	20,5	256,00
AR810150	DN 150	42,0	653,48

Króćce dwukołnierzowe FF



Nr art.	Wymiar	Waga	Cena netto [zł/szt.]
AR720100	DN 80 x 100 (8 otw.)	8,2	148,21
AR720200	DN 80 x 200	9,1	166,74
AR720208	DN 80 x 200 (8 otw.)	9,1	166,74
AR720300	DN 80 x 300	10,0	175,16
AR720308	DN 80 x 300 (8 otw.)	10,0	175,16
AR720400	DN 80 x 400	10,9	200,42
AR720408	DN 80 x 400 (8 otw.)	10,9	200,42
AR720500	DN 80 x 500	11,8	229,05
AR720508	DN 80 x 500 (8 otw.)	11,8	229,05
AR720588	DN 80 x 600 (8 otw.) sfero	12,7	352,00
AR720888	DN 80 x 800 (8 otw.) sfero	14,5	385,69
AR720188	DN 80 x 1000 (8 otw.) sfero	16,3	458,11
AR721200	DN 100 x 200	12,5	192,00
AR721300	DN 100 x 300	14,0	225,69
AR721400	DN 100 x 400	15,5	234,11
AR721500	DN 100 x 500	17,0	250,95
AR721600	DN 100 x 600 sfero	18,5	419,37
AR721800	DN 100 x 800 sfero	20,0	469,90
AR721100	DN 100 x 1000 sfero	22,5	520,42
AR722200	DN 150 x 200	18,4	335,16
AR722300	DN 150 x 300	21,6	350,32
AR722400	DN 150 x 400	24,8	375,58
AR722500	DN 150 x 500	28,0	407,58
AR722600	DN 150 x 600 sfero	31,2	587,79
AR722800	DN 150 x 800 sfero	37,6	682,11
AR722100	DN 150 x 1000 sfero	44,0	732,64
AR723200	DN 200 x 200 sfero	30,0	577,69
AR723300	DN 200 x 300 sfero	35,0	628,21
AR723400	DN 200 x 400 sfero	40,0	678,74
AR723500	DN 200 x 500 sfero	45,0	736,01
AR723600	DN 200 x 600 sfero	50,0	779,79
AR723800	DN 200 x 800 sfero	60,0	880,85
AR723100	DN 200 x 1000 sfero	70,0	981,90

Króćce jednokołnierzowe F – SFERO



Nr art.	Wymiar	Waga	Cena netto [zł/szt.]
AR730308	DN 80 x 300 (8 otw.) sfero	6,5	256,00
AR730408	DN 80 x 400 (8 otw.) sfero	7,4	299,79
AR730508	DN 80 x 500 (8 otw.) sfero	8,3	343,58
AR731300	DN 100 x 300 sfero	7,5	313,27
AR731400	DN 100 x 400 sfero	9,0	355,37
AR731500	DN 100 x 500 sfero	10,5	397,48
AR732300	DN 150 x 300 sfero	12,2	468,21
AR732400	DN 150 x 400 sfero	15,4	535,58
AR732500	DN 150 x 500 sfero	18,6	602,95
AR733300	DN 200 x 300 sfero	15,6	535,58
AR733400	DN 200 x 400 sfero	20,6	678,74
AR733500	DN 200 x 500 sfero	25,6	821,90

Kolana kołnierzowe Q

Nr art.	Wymiar	Waga	Cena netto [zł/szt.]
AR820088	DN 80 (8 otw.)	12,2	185,26
AR820100	DN 100	16,2	205,48
AR820150	DN 150	28,0	434,53
AR820200	DN 200	52,0	754,53

Trójniki kołnierzowe T

Nr art.	Wymiar	Waga	Cena netto [zł/szt.]
AR830050	DN 50 x 50	11,7	188,63
AR831050	DN 80 x 50	16,3	235,79
AR831058	DN 80 x 50 (8 otw.)	16,3	235,79
AR831080	DN 80 x 80	17,0	252,63
AR831088	DN 80 x 80 (8 otw.)	17,0	252,63
AR832050	DN 100 x 50	19,4	282,95
AR832080	DN 100 x 80	20,4	289,69
AR832088	DN 100 x 80 (8 otw.)	20,4	289,69
AR832100	DN 100 x 100	21,1	306,53
AR833080	DN 150 x 80	34,0	552,42
AR833088	DN 150 x 80 (8 otw.)	34,0	552,42
AR833100	DN 150 x 100	36,0	572,64
AR833150	DN 150 x 150	40,6	606,32
AR834080	DN 200 x 80	52,0	855,58
AR834088	DN 200 x 80 (8 otw.)	52,0	855,58
AR834100	DN 200 x 100	53,0	909,48
AR834150	DN 200 x 150	55,0	943,16
AR834200	DN 200 x 200	61,0	985,27

Trójniki bosokołnierzowe TBK

Nr art.	Wymiar	Waga	Cena netto [zł/szt.]
AR840050	80 x 50	7,6	165,05
AR840080	80 x 80	10,1	215,58
AR840088	80 x 80 (8 otw.)	10,1	215,58
AR841050	100 x 50	9,2	218,95
AR841080	100 x 80	11,6	239,16
AR841088	100 x 80 (8 otw.)	11,6	239,16
AR841100	100 x 100	17,0	272,84
AR842080	150 x 80	16,4	387,37
AR842088	150 x 80 (8 otw.)	16,4	387,37
AR842100	150 x 100	20,0	421,06
AR842150	150 x 150	25,0	454,74
AR843080	200 x 80	29,0	656,85
AR843088	200 x 80 (8 otw.)	29,0	656,85
AR843100	200 x 100	37,0	690,53
AR843150	200 x 150	43,0	714,11

Zwężki kołnierzowe FFR



Nr art.	Wymiar	Waga	Cena netto [zł/szt.]
AR850050	80 x 50	7,7	138,11
AR850058	80 x 50 (8 otw.)	7,7	138,11
AR851050	100 x 50	9,0	154,95
AR851080	100 x 80	11,5	166,74
AR851088	100 x 80 (8 otw.)	11,5	166,74
AR852080	150 x 80	15,0	234,11
AR852088	150 x 80 (8 otw.)	15,0	234,11
AR852100	150 x 100	16,0	250,95
AR853080	200 x 80	19,0	286,32
AR853088	200 x 80 (8 otw.)	19,0	286,32
AR853100	200 x 100	21,5	303,16
AR853150	200 x 150	22,5	320,00

Kołnierze ślepe X

Nr art.	Wymiar	Waga	Cena netto [zł/szt.]
AR860050	DN 50	2,2	48,84
AR860080	DN 80	3,0	57,26
AR860100	DN 100	3,8	74,11
AR860150	DN 150	6,6	121,26
AR860200	DN 200	10,5	158,32
AR860250	DN 250	12,5	249,26
AR860300	DN 300	14,5	303,16

Uszczelki kołnierzowe gumowe płaskie

Nr art.	Wymiar	Waga	Cena netto [zł/szt.]
AR870050	DN 50		2,86
AR870065	DN 65		3,71
AR870080	DN 80		3,37
AR870100	DN 100		3,71
AR870125	DN 125		5,22
AR870150	DN 150		4,72
AR870200	DN 200		7,41
AR870250	DN 250		8,42
AR870300	DN 300		12,46
AR870400	DN 400		20,21

Rury drenarskie PVC-U w otulinie zgrzewanej
PN-C-89221:1998 | PN-C-89221:1998/Az1:2004

Nr art.	Nazwa artykułu	Cena netto [zł/szt.]
6120011-4	DN 50, 50 m w otulinie	312,87
6120031-4	DN 80, 50 m w otulinie	511,37
6120051-4	DN 100, 50 m w otulinie	596,60
6120054-4	DN 100 25 m w otulinie	313,21
6120059	DN 125 50m z filtrem PP	1 252,00
6120071	DN 160 25 m z filtrem PP	1 047,12

Rury drenarskie PVC-U
PN-C-89221:1998 | PN-C-89221:1998/Az1:2004

Nr art.	Nazwa artykułu	Cena netto [zł/szt.]
6120010-4	DN 50, 50 m	178,58
6120030-4	DN 80, 50 m	278,70
6120050-4	DN 100, 50 m	341,78
6120060	DN 125, 50 m	780,21
61200610	DN 160, 50 m	1 476,20
6120020-4	DN 50, 50 m bez otworów	178,58
6120041-4	DN 80, 50 m bez otworów	278,70
6120052-4	DN 100, 50 m bez otworów	341,78
61200640	DN 160, 50 m bez otworów	1 722,05

BEKO – pianki, markery

Nr art.	Opis	Cena netto [zł/szt.]
BE2945500	Marker Spray TecLine 500 ml - czerwony	41,10
BE2946500	Marker Spray TecLine 500 ml - zielony	33,15
BE2947500	Marker Spray TecLine 500 ml - pomarańczowy	33,15
AW9000030P	Pianka Montażowa BEKO 750 ml, pistoletowa	50,15
AW9000030W	Pianka Montażowa BEKO 750 ml, wężykowa	50,15
AW9000034	Uniwersalny czyszcik do pistoletu pianowego 500 ml	28,05
AW9000035	Pistolet do piany BEKO-blue	88,00

Kształtki drenarskie



Nr art.	Nazwa artykułu	Cena netto [zł/szt.]
6601010	Złączka drenarska uniwersalna	11,50
6602010	Trójnik drenarski uniwersalny	23,50
6603010	Zaślepka drenarska uniwersalna	13,94
6604010	Przyłącze drenarskie uniwersalne do kielicha rury PVC DN110	10,54
6605010	Przyłącze drenarskie uniwersalne zewn.na bosy koniec rury PVC DN110	9,54
6606010	Kolano drenarskie uniwersalne 2-kielichowe 90 st 100mm	7,76
6601020	Złączka drenarska 50	5,11
6601021	Złączka drenarska 50/100	11,99
66010211	Złączka drenarska 100/110	11,99
6601030	Mufa drenarska 50	2,70
6601026	Mufa drenarska 80	2,70
6606016	Kolano drenarskie 80/90 st.	5,15
6606018	Kolano drenarskie 100/90 szt.	6,60
6602020	Trójnik drenarski 50	7,22
6602022	Trójnik drenarski 100/100/90	11,55
66020221	Trójnik drenarski 100/100/45	11,67
6606080	Czwórnik drenarski 100/100/100/90 st.	12,74
6603020	Zaślepka drenarska 50	7,30

Geowłóknina

Nr art.	Nazwa artykułu	Cena netto [zł/m ²]
6600011M	Geowłóknina 100 g/m ²	3,32
660012	Geowłóknina 120 g/m ²	3,78
6600012M	Geowłóknina 150 g/m ²	4,12
660018	Geowłóknina 180 g/m ²	4,69
660019	Geowłóknina 200 g/m ²	4,92

NOWOŚĆ

Skrzynki Rainbox 3S do 12 T

Nr art.	Opis	Cena netto [zł/szt.]
GR370500	Rainbox 3S skrzynka – poj.291 l 1200 x 600 x 420 mm	399,69
GR370520	Rainbox 3S łączniki pełne	1,22
GR370525	Rainbox 3S łączniki połówki	1,10
660019	Geowłóknina 200g/m ² szer. 3 m	4,92 zł/m ²

Tunele

Tunel 150

Nr art.	Opis	Cena netto [zł/szt.]
GRT02255	Tunel rozszacujący 150	139,90
GRT02256	Dekiel 150	67,70
GRT02674	Tunel rozszacujący 300	272,70
GRT02675	Dekiel 300	76,90

Zbiorniki na wodę deszczową

Nr art.	Opis	Cena netto [zł/szt.]
ZBWM1000	Zbiornik na wodę 1000 L	1 850,00
ZBWM2000	Zbiornik na wodę 2000 L	2 850,00
ZBWM3000	Zbiornik na wodę 3000 L	3 200,00
ZBWM4000	Zbiornik na wodę 4000 L	3 933,30
ZBWM5000	Zbiornik na wodę 5000 L	5 323,30
ZBWM10000	Zbiornik na wodę 10000 L	9 989,50
ZBWM0020	Nadstawka OG 20 cm	178,00
ZBWM0040	Nadstawka OG 40 cm	230,00
ZBWM0010	Filtr do wody deszczowej	185,00

Skrzynki Rainbox 3S – komplet

Skrzynie do infiltracji wody deszczowej. Wybierz idealny dla Ciebie zestaw, gotowy w każdej chwili do zamontowania (bez użycia ciężkiego sprzętu) dzięki oryginalnemu zapakowaniu w geowłókninę.

Nr art.	Opis	Cena katalogowa [zł/kpl.]
GR370559	1 x Skrzynia Rainbox opakowana geowłókniną 291 l – 1200 x 600 x 420 mm	606,25
GR370560	2 x Skrzynia Rainbox opakowana geowłókniną 582 l – 2400 x 600 x 420 mm	1212,75
GR370570	3 x Skrzynia Rainbox opakowana geowłókniną 873 l – 3600 x 600 x 420 mm	1819,13
GR370501	Osadnik z filtrem 315 110x125	496,13
GR370502	Osadnik z filtrem 400 160x160	1356,08

Rury do nawadniania PN6

Nr art.	Nazwa artykułu	Cena netto [zł/m]
2130061M4	Rura PE 25 mm 100 m czarna	1,88
2130066M4	Rura PE 32 mm 100 m czarna	2,22
2130071M4	Rura PE 40 mm 100 m czarna	2,83
2130081M4	Rura PE 50 mm 100 m czarna	4,67
2130101M4	Rura PE 63 mm 100 m czarna	6,84
2130121M4	Rura PE 75 mm 100 m czarna	10,21

Skrzynka ogrodowa

Nr art.	Nazwa artykułu	Cena netto [zł/m]
ZBWM0090	Skrzynka ogrodowa, zawór ¼" pokrywa zielona	69,00
ZBWM0091	Skrzynka ogrodowa, zawór ¼" pokrywa brąz	69,00
ZBWM0092	Skrzynka ogrodowa, zawór 3/4" pokrywa pomarańcz	69,00

Rury do nawadniania PN10

Nr art.	Nazwa artykułu	Cena netto [zł/m]
2130311M4	Rura PE 25 mm 100 m czarna	1,88
2130320M4	Rura PE 32 mm 100 m czarna	3,50
2130330M4	Rura PE 40 mm 100 m czarna	5,31
2130047M4	Rura PE 50 mm 100 m czarna	7,83
2130056M4	Rura PE 63 mm 100 m czarna	12,49
2130351M4	Rura PE 75 mm 100 m czarna	13,82
2130502M4	Rura PE 90 mm 100 m czarna	19,91
2130552M4	Rura PE 110 mm 100 m czarna	29,38

NOWOŚĆ

Rury studzienne

	Nr art.	Nazwa artykułu	Cena netto [zł/szt.]
	3110057-4	Rura PN10 PVC 110x4,2 bez uszczelki Niebieska 3000 mm	99,38
	3110052-4	Rura PN10 PVC 110x4,2 bez uszczelki Niebieska 5000 mm	156,06
	3110058-4	Rura PN10 PVC 110x4,2 bez uszczelki Niebieska 6000 mm	189,86
	3110053-4N	Rura PN10 PVC 125x4,8 bez uszczelki Niebieska 3000 mm	130,53
	3110054-4N	Rura PN10 PVC 125x4,8 bez uszczelki Niebieska 6000 mm	253,64
	3110069-4N	Rura PN10 PVC 160x6,2 bez uszczelki Niebieska 3000 mm	212,11
	3110065-4N	Rura PN10 PVC 160x6,2 bez uszczelki Niebieska 6000 mm	399,00
	3110075-4N	Rura PN10 PVC 225x8,6 bez uszczelki Niebieska 3000 mm	412,35
	3110070-4N	Rura PN10 PVC 225x8,6 bez uszczelki Niebieska 6000 mm	789,10

Głowice

	Nr art.	Nazwa artykułu	Cena netto [zł/szt.]
	SGGŁ110032	Głowica do studni głębinowej 110 / PE 32	311,24
	SGGŁ125032	Głowica do studni głębinowej 125 / PE 32	311,24
	SGGŁ125040	Głowica do studni głębinowej 125 / PE 40	311,24
	SGGŁ160032	Głowica do studni głębinowej 160 / PE 32	311,24
	SGGŁ160040	Głowica do studni głębinowej 160 / PE 40	311,24
	SGGŁ160050	Głowica do studni głębinowej 160 / PE 50	398,78
	SGGŁ160063	Głowica do studni głębinowej 160 / PE 63	404,86
	SGGŁ160G40M	Głowica do studni głębinowej 160 złączka z gwintem 6/4" mosiądz	368,38
	SGGŁ160G40C	Głowica do studni głębinowej 160 złączka z gwintem 6/4" ocynk	410,94
	SGGŁ225032	Głowica do studni głębinowej 225 / PE 32	479,02
	SGGŁ225040	Głowica do studni głębinowej 225 / PE 40	479,02
	SGGŁ225050	Głowica do studni głębinowej 225 / PE 50	496,04
	SGGŁ225063	Głowica do studni głębinowej 225 / PE 63	510,63
	SGGŁ225G50C	Głowica do studni 225x2" złączki ocynkowane	479,02
	SGGŁ225G50M	Głowica do studni 225x2" złączki mosiężne	553,18

Stożek

	Nr art.	Nazwa artykułu	Cena netto [zł/szt.]
	SGST125160	Stożek prowadzący rurę studzienną 125-160	52,69

NOWOŚĆ

Rury z gwintem

	Nr art.	Nazwa artykułu	Cena netto [zł/szt.]
	SOT30402	Rura studzienna z gwintem TTFS DN125x5,0/4m	298,36

Rury studzienne firmy DYKA wyprodukowane są z niezmiętkowanego poli(chlorku winylu) (PVC-U) i służą zabezpieczeniu ścian odwiertu przed zaciśnięciem i tym samym ochronie umieszczonej wewnątrz pompy głębinowej.

Oferowane przez nas rury wykonane są z wysokiej jakości materiału i charakteryzują się trwałością i wytrzymałością na występujące w odwiercie siły boczne zgniatające.

NOWOŚĆ

Filtry studzienne

	Nr art.	Nazwa artykułu	Cena netto [zł/szt.]
	SOT30265	Filtr 125/115 TTFS Długość 4m Szczelina: 1mm	344,98
	SOT34079	Filtr 125/115 TTFS Długość 4m Szczelina: 2mm	355,13
	SOT30633	Filtr 125/115 SCC Długość 4m Szczelina: 1mm	257,56
	SOT31690	Filtr 125/115 SCC Długość 4m Szczelina: 2mm	258,59
	SOT34696	Filtr 160/150 SCC Długość 4m Szczelina: 1mm	358,33
	SOT34697	Filtr 160/150 SCC Długość 4m Szczelina: 2mm	357,76
	SOT31732	Filtr 225/204 SCC Długość 4m Szczelina: 1mm	978,63
	SOT31973	Filtr 225/204 SCC Długość 4m Szczelina: 2mm	1 086,36

Rury i filtry studzienne do zabudowy kolumny studziennej studni głębinowej dostępne są w średnicach: Ø110, Ø125, Ø160, Ø225

Filtry studzienne ze szczelinami 1,0 mm lub 2,0 mm produkowane są w odcinkach 4m.

Nowość!

System rur studziennych Ø125 z połączeniami gwintowanymi i filtrami szczelinowymi.

- łatwy montaż i oszczędność czasu wykonawcy
- trwałość połączeń rur dla inwestora

DYKA PVC System Klejony Rury i Kształtki produkowany jest zgodnie z normą EN-1453 dla rur oraz EN-1329 dla kształtek.

System posiada wiele międzynarodowych certyfikatów, tj. NEN, AFNOR, BENOR. Standardowo produkujemy rury w kolorze szarym RAL 7037 oraz białym RAL 9016, w zakresie średnic od 32 mm –160 mm.

Przez DYKA System Klejony może przepływać ciecz do temperatury 60°C, a krótkotrwale nawet do 95°C.

System może wydajnie służyć jako kanalizacja wewnętrzna oraz w wielu innych aplikacjach, np. przemysłowych.

Wszystkie kształtki produkowane są z nieplastifikowanego polichlorku winylu (PVC).

Rura PVC kanalizacyjna



Nr art.	Wymiar	Cena netto [zł/szt.]
K3083890	32 3.0 4000 mm	18,82
K3083895	32 3.0 5000 mm	23,52
K2142139	40 1,8 5000 mm	27,25
K3083898	40 3,2 4000 mm biała	36,14
K3083896	40 3.0 4000 mm	24,14
K3083897	40 3.0 5000 mm	30,07
K3083915	50 3.0 4000 mm	30,70
K3083926	50 3.0 5000 mm	38,37
K3083936	75 3.0 4000 mm	46,96
K3083940	75 3.0 5000 mm	58,81
K3083970	90 3.0 4000 mm	56,88
K3083972	90 3.0 5000 mm	71,10
K2172135	110 2,2 5000 mm	92,50
K2172135-4	110 3,2 5000 mm szara b.k.	92,50
K3083985	110 3.2 5000 mm	92,50
K3083974	110 3.2 4000 mm	75,11
K3083974-4	110 3.2 4000 mm szara	75,11
K2182130	125 2,5 5000 mm	120,44
K2182130-4	125 3,2 5000 mm szara b.k.	120,44
K3084035	125 3.2 5000 mm	120,44
K3084030	125 3.2 4000 mm	94,91
K2191130	160 2,5 5000 mm	154,23
K2191130-4	160 3,2 5000 mm szara b.k.	193,83
K3084130	160 4.0 4000 mm	143,58
K3084132	160 4.0 5000 mm	179,84

Kolano dwukielichowe



Nr art.	Wymiar	Cena netto [zł/szt.]
K2253207	32/45	1,33
K2253208	32/90	2,05
K2255200	40/45	1,78
K2255208	40/90 białe	1,92
K2257203	40/90 długie	1,48
K2257202	40/90 krótkie	1,48
K2255205	50/45 białe	5,71
K2255206	50/45 szare	2,07
K2255210	50/90 białe	6,01
K2255211	50/90 szare	2,23
K2255213	50/90 szare krótkie	2,23
K2263203	75/45	3,85
K2265206	75/90	5,18
K2279207	90/45	5,63
K2281201	90/90	7,11
K2267209	110/45	7,11
K2269201	110/90	9,92
K2269202	110/90 krótkie	13,93
K2271206	125/45'	9,49
K2273209	125/90	17,78
K2273500	125/90 krótkie	14,52
K2277205	160/45	41,42
K2277204	160/90	30,66

Kolano jednokielichowe



Nr art.	Wymiar	Cena netto [zł/szt.]
K2205203	40/45	1,63
K2207206	40/90	1,63
K2207207	40/90 białe	1,92
K2255204	50/45 białe	6,19
K2255207	50/45 szare	2,07
K2255209	50/90 białe	6,30
K2255212	50/90 szare	2,23
K2205207	75/45	3,70
K2221210	110/45	8,00
K2221208	110/90 długie	12,60
K2221207	110/90 krótkie	13,48
K2221209	125/45	9,63
K2223503	125/90	14,67
K2227207	160/90	30,81

Trójnik trzykielichowy



Nr art.	Wymiar	Cena netto [zł/szt.]
K2393211	40x40/45	3,10
K2663201	40x40/90°	2,69
K2393209	50x40/45	3,63
K2675200	50x40/90	8,78
K2393210	50x50/45	4,18
K2671205	50x50/90	3,78
K239321	50x50/90 łukowy	4,16
K2393212	75x40/45	6,86
K2393207	75x40/90	5,79
K2393213	75x50/45	5,39
K2393202	75x50/90	6,06
K2667206	75x75/45	8,76
K2667207	75x75x90	12,39
K2393203	90x90/45	9,96
K2393204	90x90/90	7,54
K2393214	110x40/45	9,42
K2660202	110x40/90	8,34
K2656604	110x40/90 łukowy	16,58
K2393215	110x50/45	8,49
K2393217	110x50/90	8,49
K2656605	110x50/90 łukowy	12,12
K2393216	110x75/45	9,69
K2393218	110x75/90	13,47
K2669199	110x110/45	14,55
K2669200	110x110/90	13,87
K2393206	110x110/90 łukowy	14,40
K2671201	125x50/90	13,20
K2393205	125x110/90	22,98
K2671198	125x125/45	23,84
K2671204	125x125/90	19,94
K2389206	160x110/45	49,24
K2389207	160x110/90	27,75
K2391201	160x125/90	28,01
K2673208	160x160/45	44,99
K2673207	160x160/90	32,32

Trójnik dwukielichowy



Nr art.	Wymiar	Cena netto [zł/szt.]
K2351149	40x40/45	4,66
K2671206	50x50/45	6,50
K2671202	50x50/90	5,94
K2671203	75x75/90	12,87
K2351154	110x110/45	16,67
K2351150	110x110/90	23,49
K2351151	110x40/45	12,02
K2351152	110x50/45	12,44
K2351153	110x75/45	14,56
K2351200	125x125/90	23,73

Mufa kompensacyjna



Nr art.	Wymiar	Cena netto [zł/szt.]
K2640104	40mm	18,82
K2637200	90mm	2,73
K2640708	125 mm	40,89

Redukcja centryczna



Nr art.	Wymiar	Cena netto [zł/szt.]
K2413201	40x32	1,04
K2413206	50x40	1,33
K2413204	160x110	16,30
K2413205	160x125	16,00

Redukcja podwójna

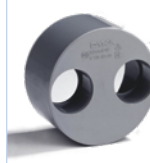

Nr art.	Wymiar	Cena netto [zł/szt.]
K2444402	110/40 podwójna	8,00
K2444403	110/50 podwójna	8,14

Redukcja ekscentryczna



Nr art.	Wymiar	Cena netto [zł/szt.]
K2413209	75x40	2,82
K2434202	75x50	3,26
K2442108	90x40	6,37
K2434203	90x75	6,78
K2442110	90x75	6,78
K2435209	110x40	5,48
K2413210	110x50	5,48
K2413207	110x75	6,67
K2444208	110x90	7,26
K2441209	125x110	10,82
K2440300	125x90	12,08

Akcesoria



Nr art.	Opis	Cena netto [zł/szt.]
K0003000	Klej do PVC 0,25 l	29,48
K0004006	Klej do PVC 1 l	86,22
K0005002	Klej do PVC 5 l	304,41
K0016004	PVC Cleaner 0,25 l	31,70
K0015008	PVC Cleaner 1 l	75,40

Zaślepka PVC



Nr art.	Wymiar	Cena netto [zł/szt.]
K2605105	40	0,68
K2605104	50	0,80
K2613200	75	2,69
K2613204	90	4,44
K2615207	110	4,44
K2617200	125	5,39

Zaślepka z nakr. PVC



Nr art.	Wymiar	Cena netto [zł/szt.]
K2641208	40	3,73
K2641209	50	5,39
K2643200	75	8,49
K2641210	110	10,91
K2645203	125	14,00
K2646200	160	25,19
K2646201	200	47,93

Złączka dwukielichowa



Nr art.	Wymiar	Cena netto [zł/szt.]
K2501201	40mm	0,80
K2502208	50mm	1,21
K2503204	75mm	2,83
K2507200	90mm	6,06
K2504200	110 mm	4,31
K2505207	125 mm	6,33
K2506203	160 mm	9,84

DYKA przydomowe, lekkie, z PP, ruszt ocynk kl. A15

	Nr art.	Opis	Cena netto [zł/szt.]
	6200028A	KORYTKO 1000X130X105 KL. A15 RUSZT METAL "DYKA"	55,13
	6200025	Korytka 1000x130x105 kl. A15 ruszt tworzywo "DYKA"	50,93
	6200030	Zakończenie kanału z tworzywa sztucznego	21,00
	6200030L	Zaslepka z króćcem 110 lewa	21,00
	6200030P	Zaslepka z króćcem 110 prawa	21,00
	6200032	Odpływ dolny 110 z tworzywa sztucznego	21,00

HOME przydomowe, z polimerobetonu, ruszt ocynk kl. A15

	Nr art.	Opis	Cena netto [zł/szt.]
	SE10091100P	SELF-HOME B=100 H=90 1 m z króćcem + ruszt szcz. 10 mm FIX ocynk A15	133,20
	SE10091100S	SELF-HOME B=100 H=90 1 m standard + ruszt szcz. 10 mm FIX ocynk A15	97,30
	AE10072000	ścianka czołowa SELF B=100 H=90 / H=100 bez wyjścia	17,38
	AE10082000	ścianka czołowa SELF B=100 H=90 z wyjściem śr. 110	31,28
	AU10011101	osadnik piasku SELF B=100 0,5 m + kuweta + ruszt szcz. 10 mm ocynk FIX A15 0,5 m	405,40

SELF100 z polimerobetonu, szer. 100 mm, wys. 100 mm, ruszt żeliwo kl. B125

	Nr art.	Opis	Cena netto [zł/szt.]
	SE10101324S	SELF B=100 H=100 1 m standard + ruszt szcz. 16 mm żeliwny "S" B125	225,87
	SE10105324	SELF korytka B=100 H=100 0,5 m + ruszt szczeliny 16 mm żeliwny B125 "S" 0,5 m	138,99
	AE10072000	ścianka czołowa SELF B=100 H=90 / H=100 bez wyjścia	17,38
	AE10112000	ścianka czołowa SELF B=100 H=100 z wyjściem śr. 110	34,75
	AU10011324	osadnik piasku SELF B=100 0,5 m + kuweta + ruszt szcz. żeliwny "S" B125 0,5 m	449,41

SELF150 z polimerobetonu, szer. 150 mm, wys. 150 mm, ruszt żeliwo kl. B125

	Nr art.	Opis	Cena netto [zł/szt.]
	AE15002000	ścianka czołowa SELF B=150 H=195 bez wyjścia	55,60
	AE15012000	ścianka czołowa SELF B=150 H=195 Z wyjściem śr. 110	81,08
	SE15191327	SELF korytka B=150 H=195 1 m + ruszt szcz. 15 mm żeliwny B125 "S"	405,40
	SE15195327	SELF korytka B=150 H=195 0,5 m krzyżowe + ruszt szczeliny 15 mm żeliwny B125 "S"	283,78
	AU10401327	osadnik dwuczęściowy + kuweta + ruszt żeliwny szcz. "S" do kanału SELF-150 B125	805,01

TOP100 podziemne garaże, polimerobeton, ruszt żeliwo kl. C250

	Nr art.	Opis	Cena netto [zł/szt.]
	ST10061321	TOP korytka B=100 H=65 1 m + ruszt szcz. 16 mm B=100 żeliwny C250 "S"	324,32
	AE10003000	ŚCIANKA CZOŁOWA TOP B=100 H=65 nr 06 bez wyjścia	55,60
	ST10101321	TOP korytka B=100 H=100 1 m + ruszt szcz. 16 mm żeliwny C250 "S"	324,32
	ST10105321	TOP korytka B=100 H=100 0,5 m + ruszt szcz. 16 mm żeliwny C250 "S"	210,81
	AE10023000	ścianka czołowa TOP B=100 H=100 bez wyjścia	55,60
	AE10033000	ścianka czołowa TOP B=100 H=100 nr 010A z wyjściem ŚR.110	81,08
	AU10101321	osadnik piasku TOP B=100 0,5 m + kuweta + ruszt szczeliny 16 mm żeliwny C250 "S"	549,02

PARKING100 parkingi, szer. 100 mm, wys. 100 mm, ruszt żeliwny kl. C250

	Nr art.	Opis	Cena netto [zł/szt.]
	SP10001321	PARKING korytka B=100 NR 1 listwa ocynk 1 m spadek + ruszt szcz. 16 mm żeliwny C250 "S"	364,04
	SP10105321	PARKING korytka B=100 H=100 NR 0 listwa ocynk 0,5 m + ruszt szcz. 16 mm żeliwny C250 "S"	267,57
	AE10004000	ścianka czołowa PARKING B=100 NR 0 listwa ocynk bez wyjścia	55,60
	AU10201321	osadnik piasku PARKING B=100 listwa ocynk 0,5 m + kuweta + ruszt żeliwny 17 mm C250 "S"	683,38

PARKING150 parkingi, szer. 150 mm, wys. 195 mm, ruszt żeliwny kl. C250

	Nr art.	Opis	Cena netto [zł/szt.]
	SP15191330	PARKING B=150 H=195 listwa ocynk 1 m + ruszt szcz. 10 mm żeliwny C250 "S"	625,47
	SP15195330	PARKING B=150 H=195 listwa ocynk 0,5 m uniwersalne + ruszt szcz. 10 mm żeliwny C250 "S"	406,56
	AE15004000	ścianka czołowa PARKING B=150 H=195 listwa ocynk uniwersalna	125,09
	AU10401330	osadnik dwuczęściowy + kuweta + ruszt żeliwny szcz. "S" do kanału PARKING-150 C250	1 072,58

OPTIMA150 przemysłowe, szer. 150 mm, wys. 195 mm, ruszt żeliwny kl. D400/E600

	Nr art.	Opis	Cena netto [zł/szt.]
	S015191341	OPTIMA B=150 H=195 listwa ocynk 1m + ruszt szcz. żeliwny D400/E600 "S"	787,64
	S015195341	OPTIMA B=150 H=195 listwa ocynk 0,5m krzyżowy + ruszt szcz. żeliwny D400/E600 "S"	551,35
	AE15008000	ścianka czołowa OPTIMA B=150 H=195 listwa ocynk uniwersalna	125,09
	AU10401341	osadnik dwuczęściowy + kuweta + ruszt żeliwny szcz. "S" do kanału OPTIMA-150 D400/E600	1 274,12

Wpusty dachowe

	Nr art.	Wymiar	Cena netto [zł/szt.]
	V2737430	Wpust dachowy DN110 do membrany	610
	V2737420	Wpust dachowy DN110 do membrany, podgrzewany	990
	V2737413	Wpust dachowy DN110 do pokryć bitumicznych	520
	V2737410	Wpust dachowy DN110 do pokryć bitumicznych, podgrzewany	960
	V2737432	Wpust dachowy DN160 do membrany	610
	V2737422	Wpust dachowy DN160 do membrany, podgrzewany	990
	V2737415	Wpust dachowy DN160 do pokryć bitumicznych	520
	V2737412	Wpust dachowy DN160 do pokryć bitumicznych, podgrzewany	960

System grzewany PE

	Nr art.	Wymiar	Cena netto [zł/szt.]
	VF20022738	PE Kompensator-łącznik z wpustem DN110 mm	37,57
	VF20022740	PE Kompensator-łącznik z wpustem DN160 mm	124,61
	VF20022678	PE Mufa elektrooporowa DN110 mm	27,2
	VF20022680	PE Mufa elektrooporowa DN160 mm	67,49
	VF20022542	PE Kolano DN110x45°	22,61
	VF20022544	PE Kolano DN160x45°	85,85
	VF20022554	PE Kolano DN110x88,5°	31,28
	VF20022556	PE Kolano DN160x88,5°	112,88
	VF20022667	PE Czyszczyk DN110/90°	114,41
	VF20022669	PE Czyszczyk DN160/90°	241,4
	VF20021820-4	PE80 Rura DN110x4,2 L=5 m	319,6
	VF20021826-4	PE80 Rura DN160x6,2 L=5 m	561

System klejony PVC

	Nr art.	Wymiar	Cena netto [zł/szt.]
	K2501180	Złączka dwukielichowa z uszczelką - łącznik z wpustem DN110 mm	16,05
	K2504200	Złączka dwukielichowa DN110mm	4,31
	K2267209	Kolano dwukielichowe DN110/45°	6,46
	K2269201	Kolano dwukielichowe DN110/90°	9,02
	K2669200	Trójnik trzykielichowy DN110x110/90°	13,87
	K2641210	Zaślepka z nakrętką DN110	10,91
	K3083974	Rura PVC kan. 110 3.2 4000 mm	68,28
	K0003000	Klej do PVC 0,25 l	26,8
	K0004006	Klej do PVC 1 l	78,38
	K0005002	Klej do PVC 5 l	276,74
	K0016004	PVC Czyścik 0,25 l	28,82
	K0015008	PVC Czyścik 1 l	68,54



Dokumentacja techniczna

Podciśnieniowy system odwodnienia dachów Vacurain-FLEX



Dokumentacja techniczna

Podciśnieniowy system odwodnienia dachów Vacurain - FIX



DYKA
Nature's Network



DYKA
Nature's Network

**Szczegółowe informacje:
Inżynier Sprzedaży | tel. 506 030 502**

Region 1

Menedżer Regionu:
Waldemar Langner, tel: 506 030 509

Gorzów Wilk.

ul. Żeglarska 16a
66-400 Gorzów Wilk.
T: 506 030 508
E: oddzial.gorzow@dyka.com.pl
Przedstawiciel Handlowy
T: 515 087 620

Wrocław

ul Karmelkowa 29
52-437 Wrocław
T: 519 530 518
E: oddzial.wroclaw@dyka.com.pl
Przedstawiciel Handlowy
T: 506 030 503

Bolesławiec

ul. Cieszkowskiego 15
59-700 Bolesławiec
T: 519 530 508
E: oddzial.boleslawiec@dyka.com.pl
Przedstawiciel Handlowy
T: 506 030 503

Poznań

ul. Sycowska 49
60-003 Poznań
T: 519 530 517
E: oddzial.poznan@dyka.com.pl
Przedstawiciel Handlowy
T: 519 530 507

Jelcz-Laskowice

ul. Belgijska 5
55-221 Jelcz - Laskowice
T: 797 376 799
E: oddzial.jelcz@dyka.com.pl
Przedstawiciel Handlowy
T: 506 030 503

Kalisz - NOWY ODDZIAŁ

ul. Złota 46-48
62-800 Kalisz
T: 502 132 156
E: oddzial.kalisz@dyka.com.pl
Przedstawiciel Handlowy
T: 502 132 186

Region 2

Menedżer Regionu:
Paweł Chojnacki, tel: 515 087 619

Kielce

ul. Łódzka 181
25-655 Kielce
T: 506 040 726
E: oddzial.kielce@dyka.com.pl
Przedstawiciel Handlowy
T: 504 792 594

Rąbień

ul. Słowiańska 45
95-070 Łódź - Rąbień
T: 515 818 528
E: oddzial.lodz@dyka.com.pl
Przedstawiciel Handlowy
T: 519 530 511

Rzeszów

ul. Podkarpacka 10
35-082 Rzeszów
T: 519 530 510
E: oddzial.rzeszow@dyka.com.pl
Przedstawiciel Handlowy
T: 519 530 513

Chorzów

ul. Inwalidzka 11
41-506 Chorzów
T: 519 530 515
E: oddzial.slask@dyka.com.pl
Przedstawiciel Handlowy
T: 506 030 505

Kraków

ul. Jeżynowa 13
31-979 Kraków
T: 506 040 742
E: oddzial.krakow@dyka.com.pl
Przedstawiciel Handlowy
T: 506 030 504

Płock

ul. Dobrzyńska 62
09-400 Płock
T: 515 818 432
E: oddzial.plock@dyka.com.pl
Przedstawiciel Handlowy
T: 506 060 265

Region Północ

Przedstawiciel Handlowy
tel. 519 530 512



Dział Vacurain:

T: +48 71 301 00 70
E: vacurain.pl@dyka.com.pl

Przedstawiciel handlowy północ:
506 030 502

Przedstawiciel handlowy południe:
502 348 220